

IGBT Modules



V_{CES}	1200V
I_C	15A

Applications

- Motor Drivers
- AC and DC servo drive amplifier
- UPS (Uninterruptible Power Supplies)

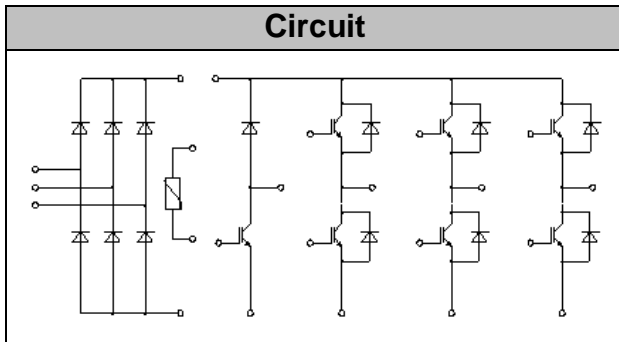

Features

- Low switching losses
- Low $V_{ce(sat)}$ with positive temperature coefficient
- Including fast & soft recovery anti-parallel FWD
- Low inductance case
- High short circuit capability(10us)
- Isolated heatsink using DBC technology
- Maximum junction temperature 175°C

● IGBT- inverter

Absolute Maximum Ratings

Parameter	Symbol	Conditions	Value	Unit
Collector-Emitter Voltage	V_{CES}	$V_{GE}=0V, I_C=1mA, T_{vj}=25^{\circ}C$	1200	V
Continuous Collector Current	I_C	$T_c=100^{\circ}C, T_{vjmax}=175^{\circ}C$	15	A
Repetitive Peak Collector Current	I_{CRM}	$t_p=1ms$	30	A
Gate-Emitter Voltage	V_{GES}	$T_{vj}=25^{\circ}C$	± 20	V
Total Power Dissipation	P_{tot}	$T_c=25^{\circ}C$ $T_{vjmax}=175^{\circ}C$	155	W



Characteristic values

Parameter	Symbol	Conditions	Value			Unit
			Min.	Typ.	Max.	
Gate-emitter Threshold Voltage	$V_{GE(th)}$	$V_{GE}=V_{CE}, I_C=1.2mA, T_{vj}=25^{\circ}C$	5.8	6.6	7.4	V
Collector-Emitter Cut-off Current	I_{CES}	$V_{CE}=1200V, V_{GE}=0V, T_{vj}=25^{\circ}C$			1.0	mA
Collector-Emitter Saturation Voltage	$V_{CE(sat)}$	$I_C=15A, V_{GE}=15V, T_{vj}=25^{\circ}C$		1.80	2.20	V
		$I_C=15A, V_{GE}=15V, T_{vj}=125^{\circ}C$		2.10		
		$I_C=15A, V_{GE}=15V, T_{vj}=150^{\circ}C$		2.20		
Gate Charge	Q_G			0.15		uC
Input Capacitance	C_{ies}	$V_{CE}=25V, V_{GE}=0V,$ $f=1MHz, T_{vj}=25^{\circ}C$		1.1		nF
Reverse Transfer Capacitance	C_{res}			0.04		nF
Gate-Emitter leakage current	I_{GES}	$V_{CE}=0V, V_{GE}=20V, T_{vj}=25^{\circ}C$			400	nA
Turn-on Delay Time	$t_{d(on)}$	$I_C=15A$ $V_{CE}=600V$ $V_{GE}=\pm 15V$ $R_G=39\Omega$ $T_{vj}=25^{\circ}C$		90		ns
Rise Time	t_r			64		ns
Turn-off Delay Time	$t_{d(off)}$			180		ns
Fall Time	t_f			135		ns
Energy Dissipation During Turn-on Time	E_{on}			1.42		mJ
Energy Dissipation During Turn-off Time	E_{off}			0.78		mJ
Turn-on Delay Time	$t_{d(on)}$	$I_C=15A$ $V_{CE}=600V$ $V_{GE}=\pm 15V$ $R_G=39\Omega$ $T_{vj}=125^{\circ}C$		95		ns
Rise Time	t_r			70		ns
Turn-off Delay Time	$t_{d(off)}$			260		ns
Fall Time	t_f			180		ns
Energy Dissipation During Turn-on Time	E_{on}			1.85		mJ
Energy Dissipation During Turn-off Time	E_{off}			1.13		mJ
SC Data	I_{sc}	$T_p \leq 10\mu s, V_{GE}=15V, T_{vj}=150^{\circ}C,$ $V_{cc}=900V, V_{CEM} \leq 1200V$		90		A



● Diode-inverter

Absolute Maximum Ratings

Parameter	Symbol	Conditions	Value	Unit
Repetitive Peak Reverse Voltage	V_{RRM}	$T_{vj}=25^{\circ}C$	1200	V
Continuous DC Forward Current	I_F		15	A
Repetitive Peak Forward Current	I_{FRM}	$t_p=1ms$	30	A
I^2t -value	I^2t	$V_R=0, t_p=10ms, T_{vj}=125^{\circ}C$	16.0	A ² s
		$V_R=0, t_p=10ms, T_{vj}=150^{\circ}C$	14.0	

Characteristic values

Parameter	Symbol	Conditions	Value			Unit
			Min.	Typ.	Max.	
Forward Voltage	V_F	$I_F=15A, T_{vj}=25^{\circ}C$		2.00	2.65	V
		$I_F=15A, T_{vj}=125^{\circ}C$		2.10		
		$I_F=15A, T_{vj}=150^{\circ}C$		2.10		
Recovered Charge	Q_{rr}	$I_F=15A$		1.20		μC
Peak Reverse Recovery Current	I_{rr}	$V_R=600V$ $-di_F/dt=600A/\mu s$		13.0		A
Reverse Recovery Energy	E_{rec}	$T_{vj}=25^{\circ}C$		0.37		mJ
Recovered Charge	Q_{rr}	$I_F=15A$		2.05		μC
Peak Reverse Recovery Current	I_{rr}	$V_R=600V$ $-di_F/dt=600A/\mu s$		12.0		A
Reverse Recovery Energy	E_{rec}	$T_{vj}=125^{\circ}C$		0.68		mJ



● IGBT-brake-chopper

Absolute Maximum Ratings

Parameter	Symbol	Conditions	Value	Unit
Collector-Emitter Voltage	V_{CES}	$V_{GE}=0V, I_C=1mA, T_{vj}=25^{\circ}C$	1200	V
Continuous Collector Current	I_C	$T_c=100^{\circ}C, T_{vjmax}=175^{\circ}C$	10	A
Repetitive Peak Collector Current	I_{CRM}	$t_p=1ms$	20	A
Gate-Emitter Voltage	V_{GES}	$T_{vj}=25^{\circ}C$	± 20	V
Total Power Dissipation	P_{tot}	$T_c=25^{\circ}C, T_{vjmax}=175^{\circ}C$	105	W

Characteristic values

Parameter	Symbol	Conditions	Value			Unit
			Min.	Typ.	Max.	
Gate-emitter Threshold Voltage	$V_{GE(th)}$	$V_{GE}=V_{CE}, I_C=0.5mA, T_{vj}=25^{\circ}C$	5.2	5.8	6.4	V
Collector-Emitter Cut-off Current	I_{CES}	$V_{CE}=1200V, V_{GE}=0V, T_{vj}=25^{\circ}C$			1.0	mA
Collector-Emitter Saturation Voltage	$V_{CE(sat)}$	$I_C=15A, V_{GE}=15V, T_{vj}=25^{\circ}C$		1.85	2.25	V
		$I_C=15A, V_{GE}=15V, T_{vj}=125^{\circ}C$		2.15		
		$I_C=15A, V_{GE}=15V, T_{vj}=150^{\circ}C$		2.25		
Gate Charge	Q_G			0.09		μC
Input Capacitance	C_{ies}	$V_{CE}=25V, V_{GE}=0V, f=1MHz, T_{vj}=25^{\circ}C$		1.35		nF
Reverse Transfer Capacitance	C_{res}			0.08		nF
Gate-Emitter leakage current	I_{GES}	$V_{CE}=0V, V_{GE}=20V, T_{vj}=25^{\circ}C$			400	nA
Turn-on Delay Time	$t_{d(on)}$	$I_C=15A, V_{CE}=600V, V_{GE}=\pm 15V, R_G=39\Omega, T_{vj}=25^{\circ}C$		46		ns
Rise Time	t_r			45		ns
Turn-off Delay Time	$t_{d(off)}$			182		ns
Fall Time	t_f			168		ns
Energy Dissipation During Turn-on Time	E_{on}			0.92		mJ
Energy Dissipation During Turn-off Time	E_{off}			0.56		mJ



Turn-on Delay Time	$t_{d(on)}$	$I_C = 15A$ $V_{CE} = 600V$ $V_{GE} = \pm 15V$ $R_G = 39\Omega$ $T_{vj} = 125^\circ C$	46	ns
Rise Time	t_r		63	ns
Turn-off Delay Time	$t_{d(off)}$		248	ns
Fall Time	t_f		220	ns
Energy Dissipation During Turn-on Time	E_{on}		1.37	mJ
Energy Dissipation During Turn-off Time	E_{off}		0.81	mJ
SC Data	I_{sc}	$T_p \leq 10\mu s, V_{GE} = 15V, T_{vj} = 150^\circ C,$ $V_{cc} = 800V, V_{CEM} \leq 1200V$	35	A

● Diode-Brake-Chopper

Absolute Maximum Ratings

Parameter	Symbol	Conditions	Value	Unit
Repetitive Peak Reverse Voltage	V_{RRM}	$T_j = 25^\circ C$	1200	V
Continuous DC Forward Current	I_F		10	A
Repetitive Peak Forward Current	I_{FRM}	$t_p = 1ms$	20	A
I^2t -value	I^2t	$V_R = 0, t_p = 10ms, T_j = 125^\circ C$	16.0	A ² s
		$V_R = 0, t_p = 10ms, T_j = 150^\circ C$	14.0	

Characteristic values

Parameter	Symbol	Conditions	Value			Unit
			Min.	Typ.	Max.	
Forward Voltage	V_F	$I_F = 10A, T_{vj} = 25^\circ C$		1.75	2.25	V
		$I_F = 10A, T_{vj} = 125^\circ C$		1.75		
		$I_F = 10A, T_{vj} = 150^\circ C$		1.75		
Recovered Charge	Q_{rr}	$I_F = 10A$		0.90		μC
Peak Reverse Recovery Current	I_{rr}	$V_R = 600V$ $-di_F/dt = 500A/\mu s$		12.5		A
Reverse Recovery Energy	E_{rec}	$T_{vj} = 25^\circ C$		0.25		mJ
Recovered Charge	Q_{rr}	$I_F = 10A$		1.70		μC
Peak Reverse Recovery Current	I_{rr}	$V_R = 600V$ $-di_F/dt = 500A/\mu s$		10.4		A
Reverse Recovery Energy	E_{rec}	$T_{vj} = 125^\circ C$		0.50		mJ



● Diode-Rectifier

Absolute Maximum Ratings

Parameter	Symbol	Conditions	Value	Unit
Repetitive Peak Reverse Voltage	V_{RRM}	$T_j=25^{\circ}\text{C}$	1600	V
Average output Current 50/60Hz, sine wave	$I_{F(AV)}$	$T_c=100^{\circ}\text{C}$	20	A
Maximum RMS Current at Rectifier Output	I_{RMSM}	$T_c=100^{\circ}\text{C}$	40	A
Surge Forward Current	I_{FSM}	$V_R=0, t_p=10\text{ms}, T_j=45^{\circ}\text{C}$	270	A
I^2t -value	I^2t	$V_R=0, t_p=10\text{ms}, T_j=45^{\circ}\text{C}$	360	A^2s

Characteristic values

Parameter	Symbol	Conditions	Value			Unit
			Min.	Typ.	Max.	
Diode Forward Voltage	V_F	$I_F=15\text{A}, T_j=150^{\circ}\text{C}$		0.96		V
Reverse Current	I_R	$T_j=150^{\circ}\text{C}, V_R=1600\text{V}$			1.0	mA

● NTC-Thermistor

Characteristic values

Parameter	Symbol	Conditions	Value			Unit
			Min.	Typ.	Max.	
Rated Resistance	R_{25}			5.0		$\text{k}\Omega$
Deviation of R_{100}	$\Delta R/R$	$T_C=100, R_{100}=493.3\ \Omega$	-5		5	%
Power Dissipation	P_{25}				20.0	mW
B-value	$B_{25/50}$	$R_2=R_{25}\exp[B_{25/50}(1/T_2-1/(298.15\text{K}))]$		3375		K



● **Module Characteristics ($T_C=25^\circ\text{C}$ unless otherwise specified)**

Parameter	Symbol	Conditions	Value			Unit
			Min.	Typ.	Max.	
Isolation voltage	V_{isol}	$t=1\text{min}, f=50\text{Hz}$	2500			V
Maximum Junction Temperature	T_{jmax}				175	$^\circ\text{C}$
Operating Junction Temperature	$T_{\text{vj op}}$		-40		150	$^\circ\text{C}$
Storage Temperature	T_{stg}		-40		125	$^\circ\text{C}$
Stray-inductance-module	L_{SCE}			30		nH
Module lead resistance, terminals-chip	$R_{\text{cc'+EE'}}$	$T_C=25^\circ\text{C}$, per switch		8.00		m Ω
	$R_{\text{AA'+CC'}}$			6.00		
Thermal Resistance Junction-to Case	$R_{\theta\text{JC}}$	per IGBT-inverter		0.95	1.05	K/W
		per Diode-inverter		1.75	1.90	
		per IGBT-brake-copper		1.25	1.40	
		per Diode-chopper		1.75	1.90	
		per Diode-rectifier		1.03	1.13	
Thermal Resistance Case-to Sink	$R_{\theta\text{CS}}$	per IGBT-inverter		0.95		K/W
		per Diode-inverter		1.30		
		per IGBT-brake-copper		1.15		
		per Diode-chopper		1.30		
		per Diode-rectifier		1.17		
		per Module		0.058		
Mounting Force Per Clamp	F		20		50	N
Weight of Module	G			25		g

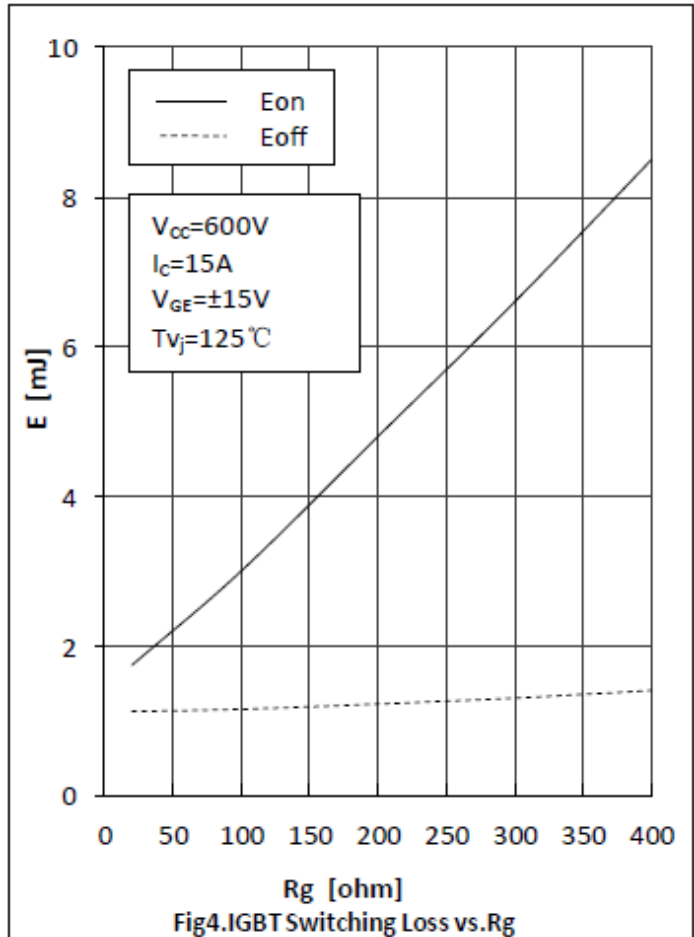
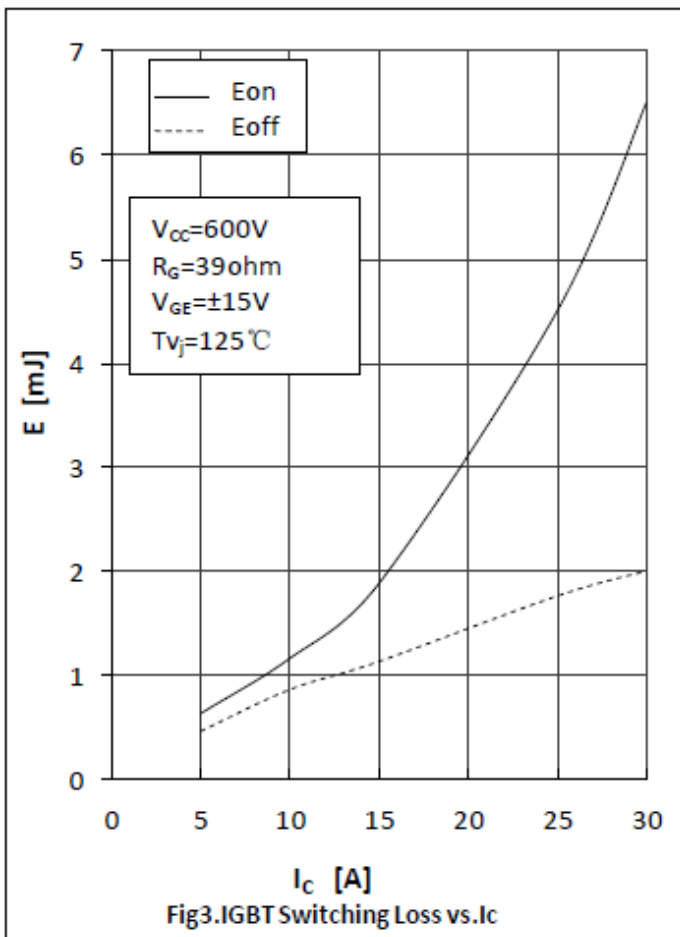
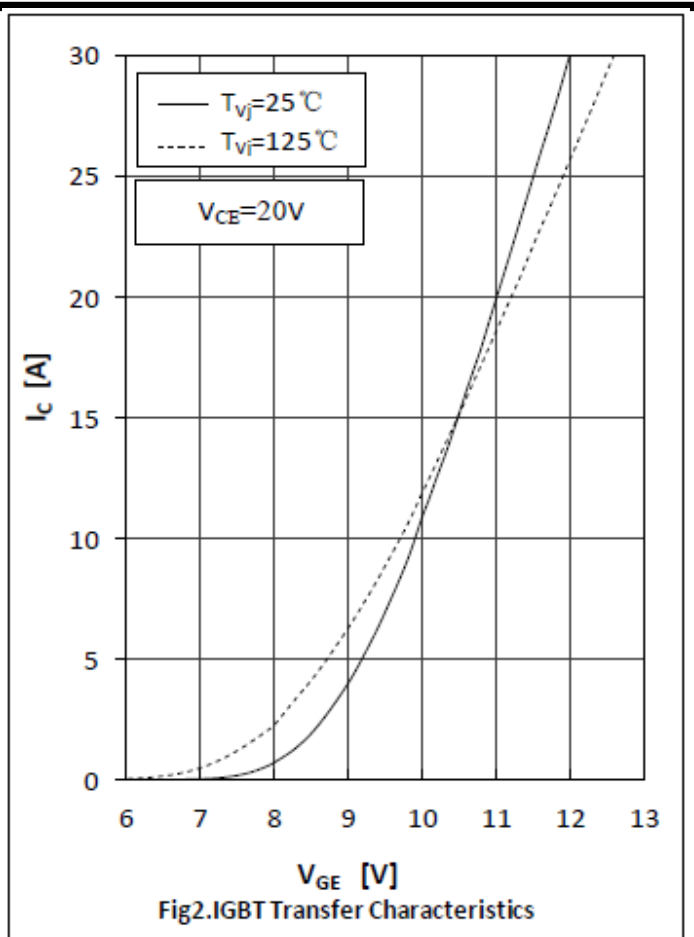
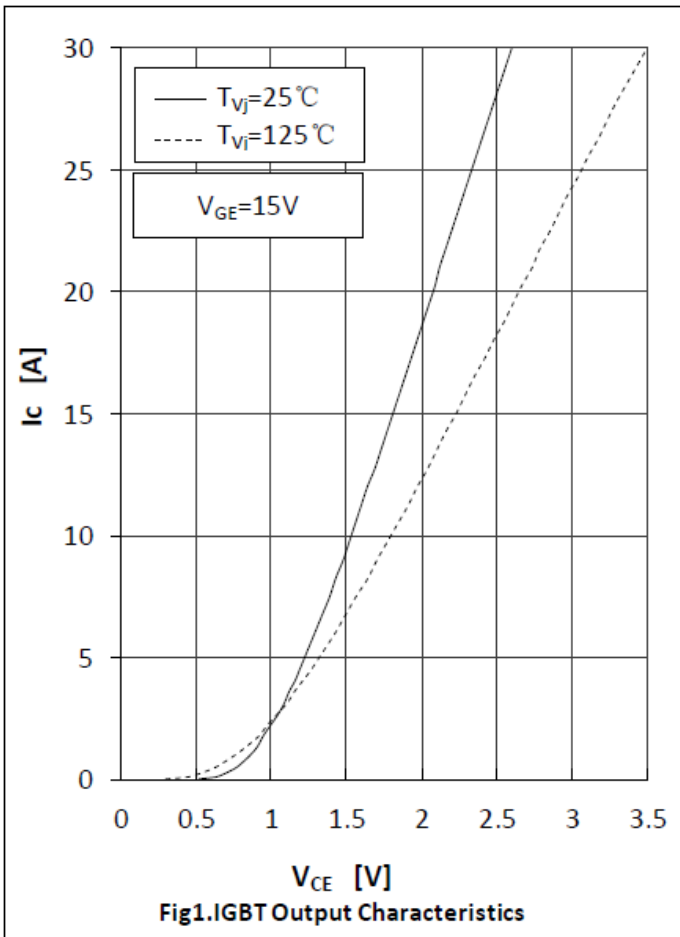

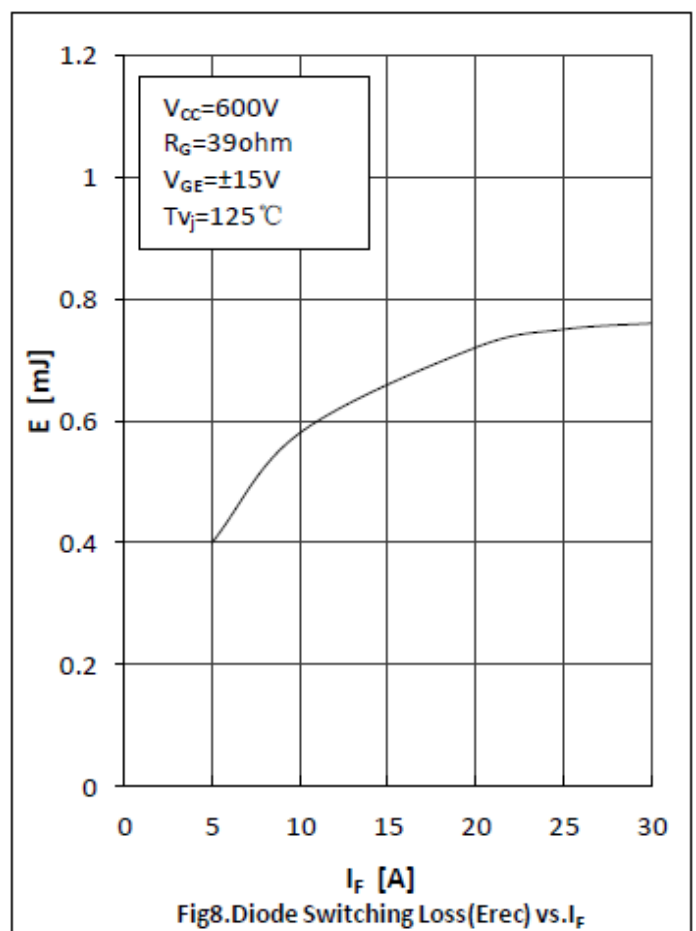
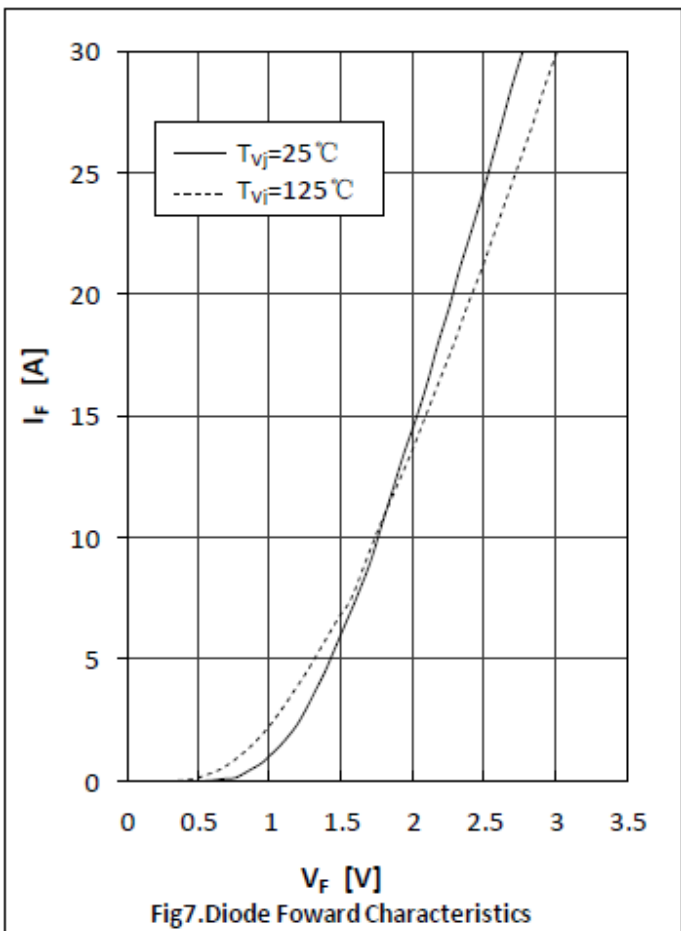
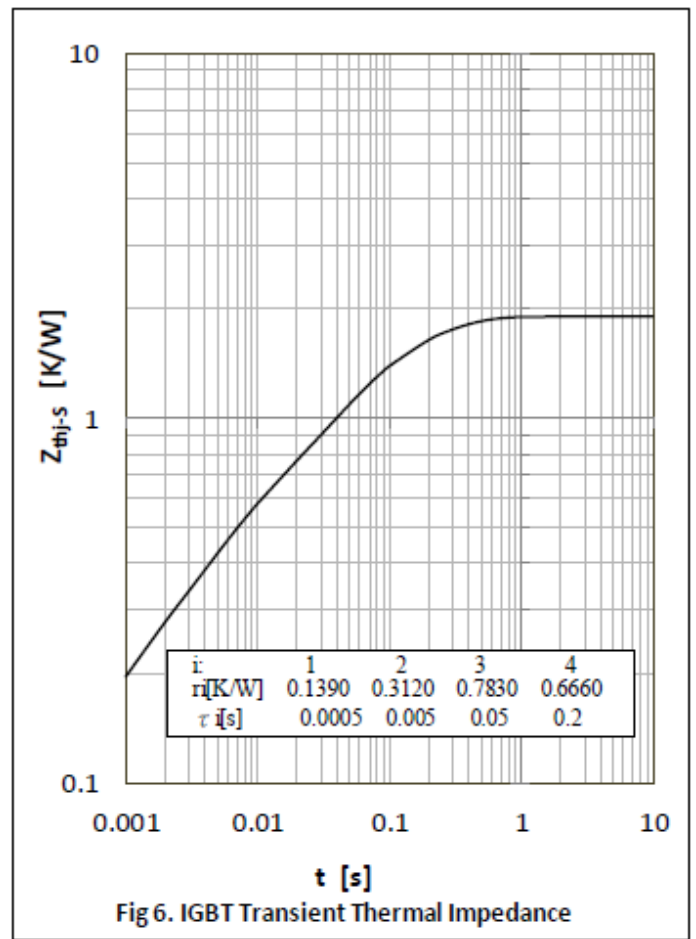
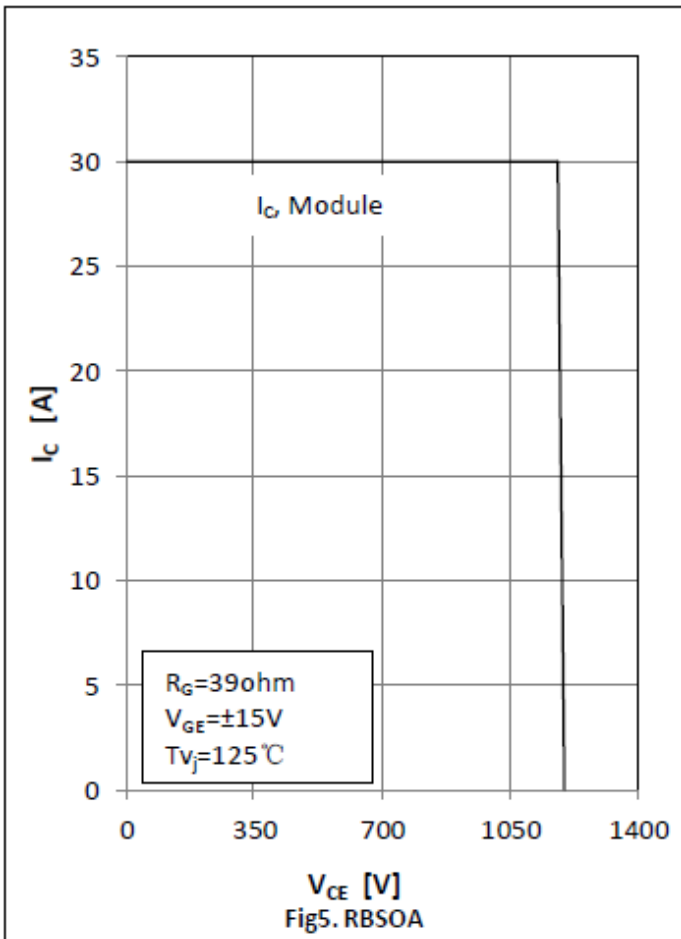

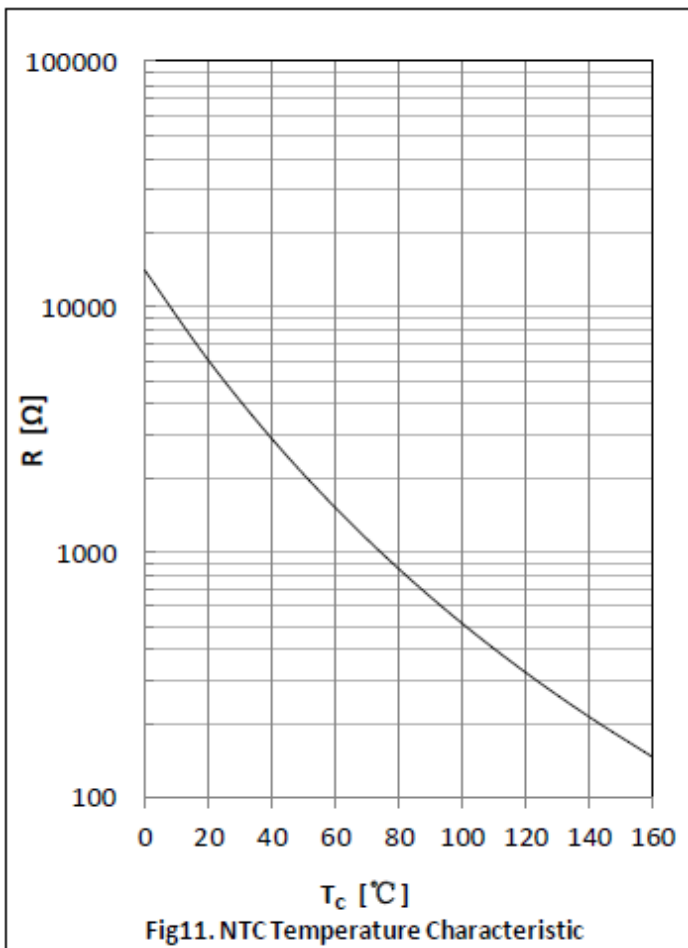
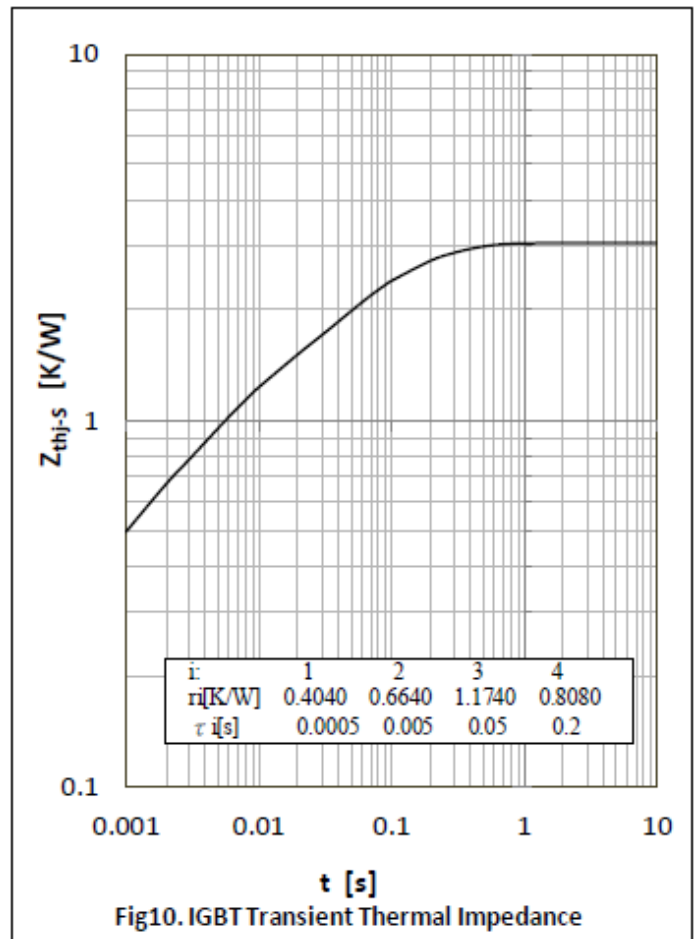
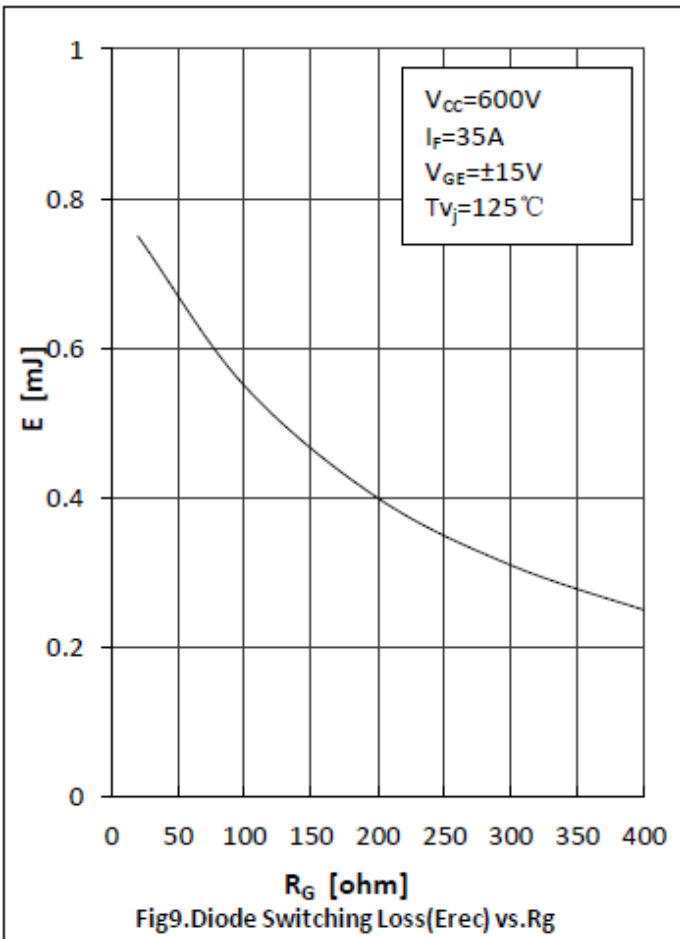

● **Circuit Diagram**

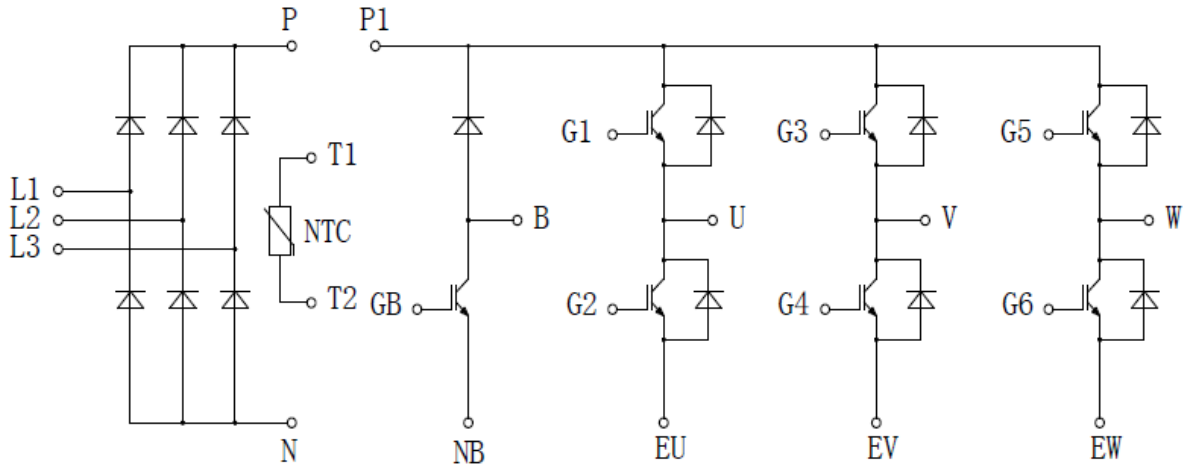

● **Package Outline Information**

