

## N-Channel Enhancement Mode Field Effect Transistor

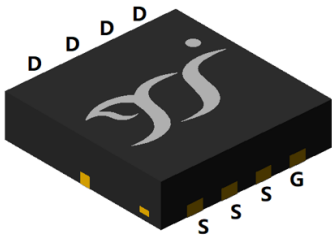

Top View

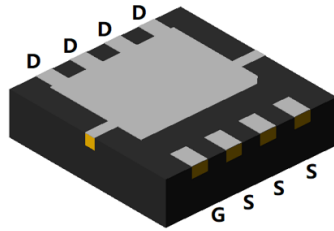

Bottom View

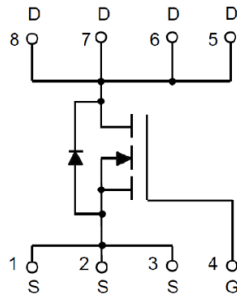

**DFN3333-8L**

### Product Summary

- $V_{DS}$  30V
- $I_D$  30A
- $R_{DS(ON)}$  (at  $V_{GS}=10V$ ) < 9 mohm
- $R_{DS(ON)}$  (at  $V_{GS}=4.5V$ ) < 13 mohm
- 100% EAS Tested

### General Description

- Trench Power LV MOSFET technology
- Excellent package for heat dissipation
- High density cell design for low  $R_{DS(ON)}$
- Moisture Sensitivity Level 3
- Epoxy Meets UL 94 V-0 Flammability Rating
- Halogen Free

### Applications

- High current load applications
- Load switching
- Hard switched and high frequency circuits
- Uninterruptible power supply

### ■ Absolute Maximum Ratings ( $T_A=25^\circ C$ unless otherwise noted)

Parameter		Symbol	Limit	Unit
Drain-source Voltage		$V_{DS}$	30	V
Gate-source Voltage		$V_{GS}$	$\pm 20$	V
Drain Current	$T_A=25^\circ C$	$I_D$	14	A
	$T_A=100^\circ C$		9	
	$T_C=25^\circ C$		30	
	$T_C=100^\circ C$		19	
Pulsed Drain Current <sup>A</sup>		$I_{DM}$	115	A
Total Power Dissipation	$T_A=25^\circ C$	$P_D$	2.5	W
	$T_A=100^\circ C$		1	
	$T_C=25^\circ C$		17	
	$T_C=100^\circ C$		7	
Single Pulse Avalanche Energy <sup>B</sup>		$E_{AS}$	60.5	mJ
Thermal Resistance Junction-to-Case <sup>C</sup>		$R_{\theta JC}$	7.1	$^\circ C/W$
Thermal Resistance Junction-to-Ambient <sup>C</sup>		$R_{\theta JA}$	50	$^\circ C/W$
Junction and Storage Temperature Range		$T_J, T_{STG}$	-55~+150	$^\circ C$

### ■ Ordering Information (Example)

PREFERRED P/N	PACKING CODE	Marking	MINIMUM PACKAGE(pcs)	INNER BOX QUANTITY(pcs)	OUTER CARTON QUANTITY(pcs)	DELIVERY MODE
YJQ30N03A	F1	Q30N03	5000	10000	100000	13" reel



# YJQ30N03A

## ■ Electrical Characteristics (T<sub>J</sub>=25°C unless otherwise noted)

Parameter	Symbol	Conditions	Min	Typ	Max	Units
<b>Static Parameter</b>						
Drain-Source Breakdown Voltage	BV <sub>DSS</sub>	V <sub>GS</sub> = 0V, I <sub>D</sub> =250μA	30			V
Zero Gate Voltage Drain Current	I <sub>DSS</sub>	V <sub>DS</sub> =30V, V <sub>GS</sub> =0V	T <sub>J</sub> =25°C		1	μA
			T <sub>J</sub> =150°C		100	
Gate-Body Leakage Current	I <sub>GSS</sub>	V <sub>GS</sub> = ±20V, V <sub>DS</sub> =0V			±100	nA
Gate Threshold Voltage	V <sub>GS(th)</sub>	V <sub>DS</sub> = V <sub>GS</sub> , I <sub>D</sub> =250μA	1.0	1.5	2.5	V
Static Drain-Source On-Resistance	R <sub>DS(on)</sub>	V <sub>GS</sub> = 10V, I <sub>D</sub> =15A		5.8	9	mΩ
		V <sub>GS</sub> = 4.5V, I <sub>D</sub> =15A		10	13	
Diode Forward Voltage	V <sub>SD</sub>	I <sub>S</sub> =15A, V <sub>GS</sub> =0V		0.85	1.2	V
Maximum Body-Diode Continuous Current	I <sub>S</sub>				30	A
<b>Dynamic Parameters</b>						
Input Capacitance	C <sub>iss</sub>	V <sub>DS</sub> =15V, V <sub>GS</sub> =0V, f=1MHZ		1015		pF
Output Capacitance	C <sub>oss</sub>			201		
Reverse Transfer Capacitance	C <sub>rss</sub>			164		
Gate Resistance	R <sub>g</sub>	f= 1MHZ		1.5		Ω
<b>Switching Parameters</b>						
Total Gate Charge	Q <sub>g</sub>	V <sub>GS</sub> =10V, V <sub>DS</sub> =15V, I <sub>D</sub> =20A		23.6		nC
Total Gate Charge	Q <sub>g(4.5V)</sub>			12.9		
Gate-Source Charge	Q <sub>gs</sub>			3.9		
Gate-Drain Charge	Q <sub>gd</sub>			7		
Reverse Recovery Charge	Q <sub>rr</sub>	I <sub>F</sub> =15A, di/dt=100A/us		0.2		
Reverse Recovery Time	t <sub>rr</sub>			5		
Turn-on Delay Time	t <sub>D(on)</sub>	V <sub>GS</sub> =10V, V <sub>DD</sub> =20V, I <sub>D</sub> =2A, R <sub>GEN</sub> =3Ω		7		ns
Turn-on Rise Time	t <sub>r</sub>			19		
Turn-off Delay Time	t <sub>D(off)</sub>			24		
Turn-off fall Time	t <sub>f</sub>			24		

A. Pulse Test: Pulse Width ≤ 300μs, Duty cycle ≤ 2%.

B. T<sub>J</sub>=25°C, V<sub>DD</sub>=25V, V<sub>G</sub>=10V, L=1mH, I<sub>AS</sub>=11A

C. R<sub>θJA</sub> is the sum of the junction-to-case and case-to-ambient thermal resistance, where the case thermal reference is defined as the solder mounting surface of the drain pins. R<sub>θJC</sub> is guaranteed by design, while R<sub>θJA</sub> is determined by the board design. The maximum rating presented here is based on mounting on a 1 in 2 pad of 2oz copper.



■ Typical Performance Characteristics

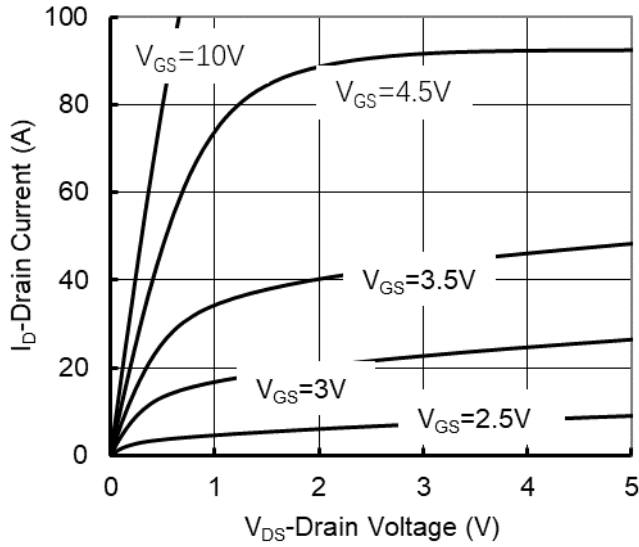

Figure1. Output Characteristics

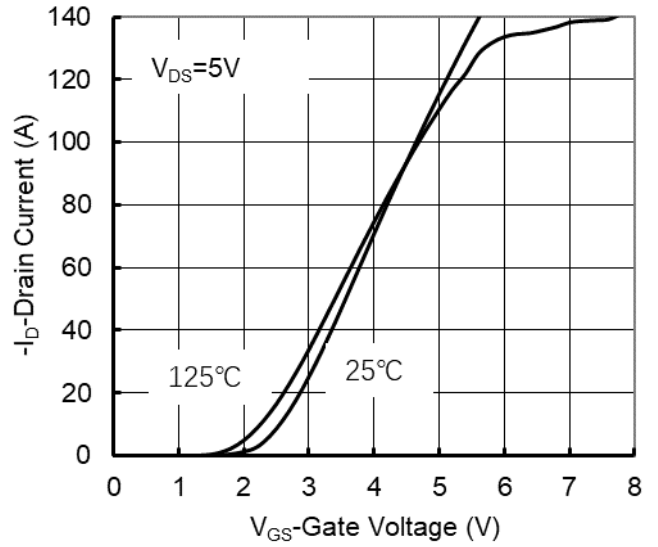

Figure2. Transfer Characteristics

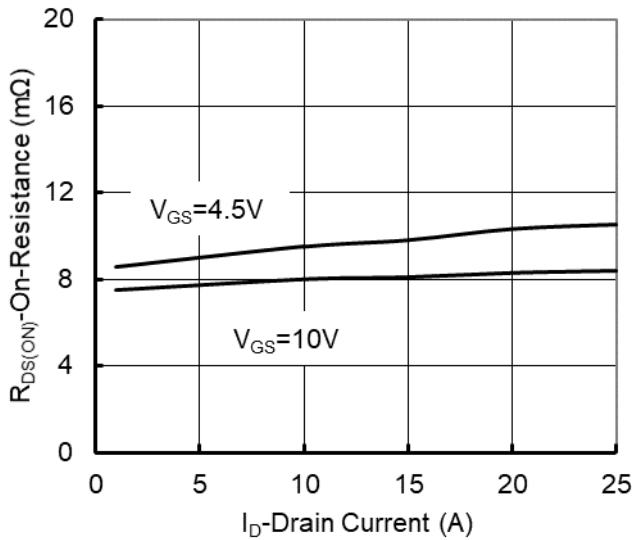

Figure 3: On-Resistance vs. Drain Current and Gate Voltage

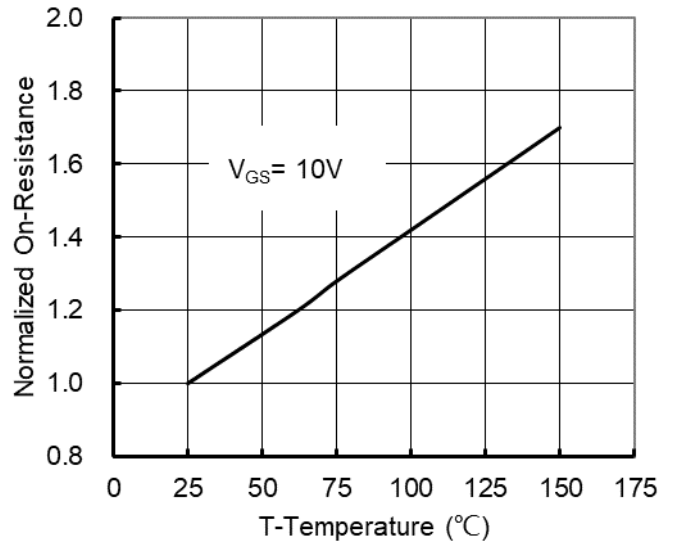

Figure 4: On-Resistance vs. Junction Temperature

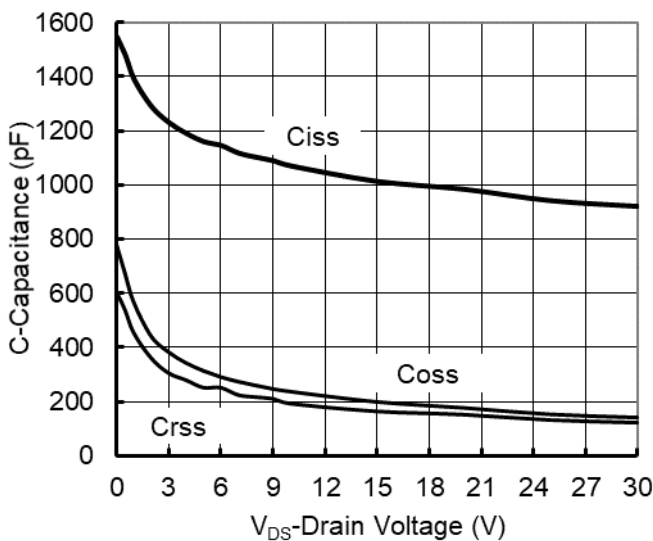

Figure5. Capacitance Characteristics

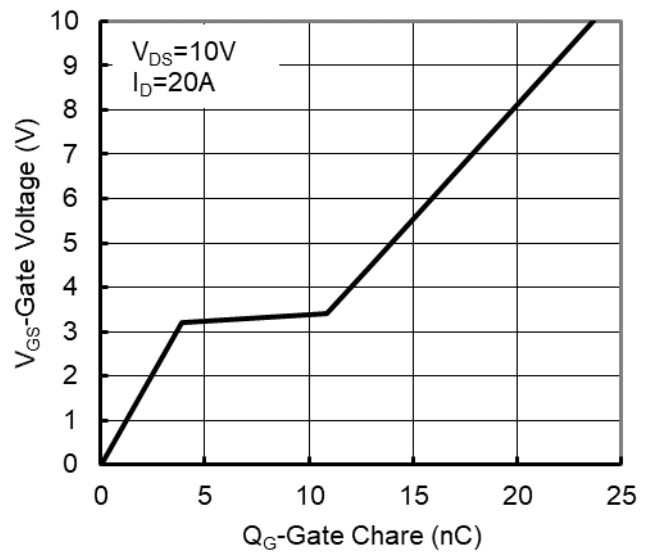

Figure6. Gate Charge



# YJQ30N03A

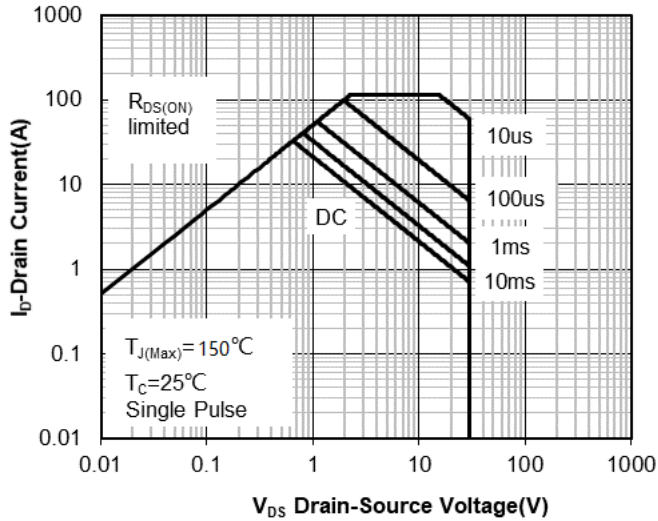

Figure7. Safe Operation Area

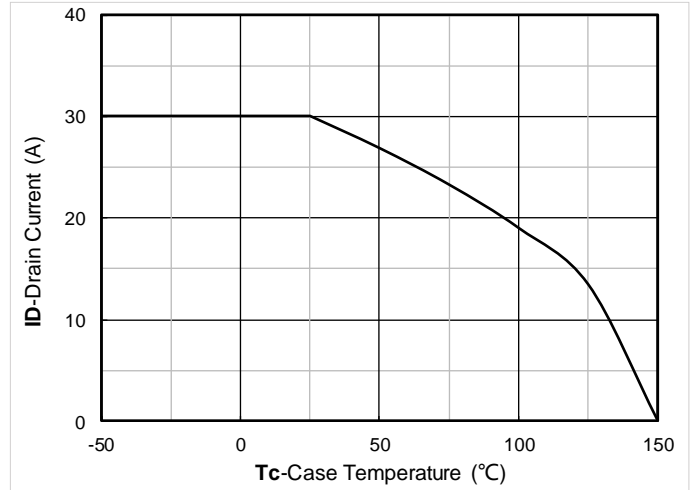

Figure8. Maximum Continuous Drain Current vs Case Temperature

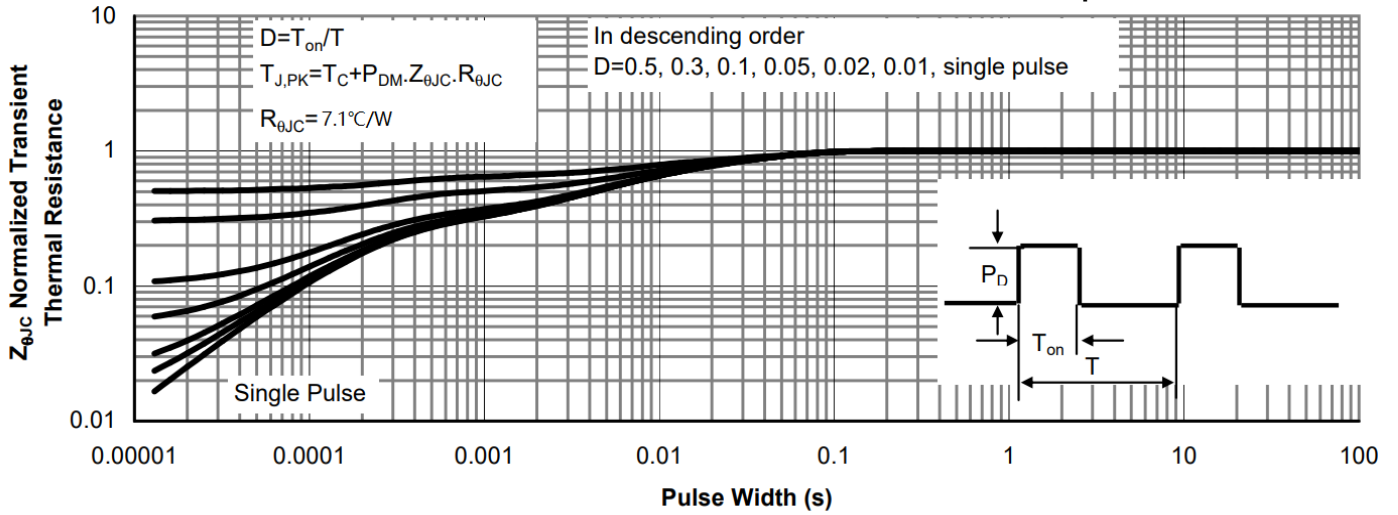
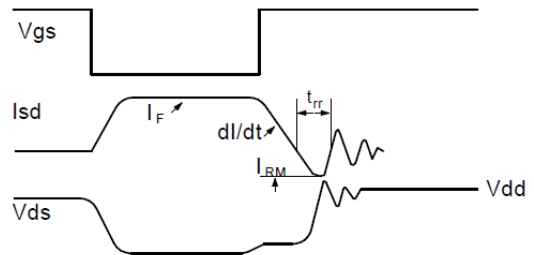
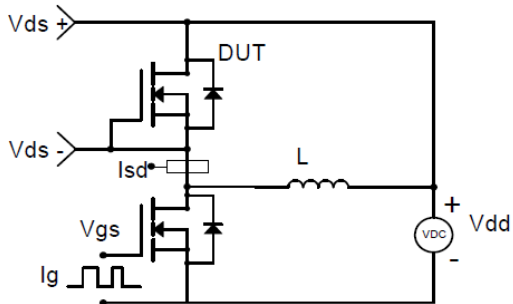

Figure9. Normalized Maximum Transient Thermal Impedance



**Resistive Switching Test Circuit & Waveforms**



**Diode Recovery Test Circuit & Waveforms**

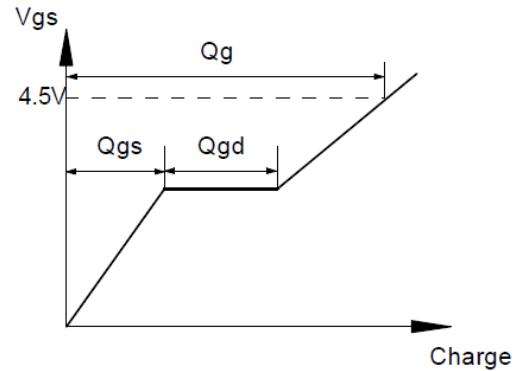
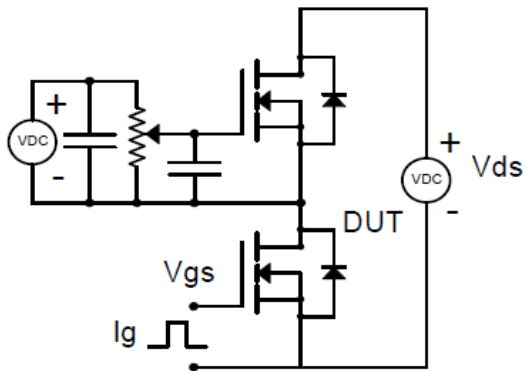

**Gate Charge Test Circuit & Waveform**

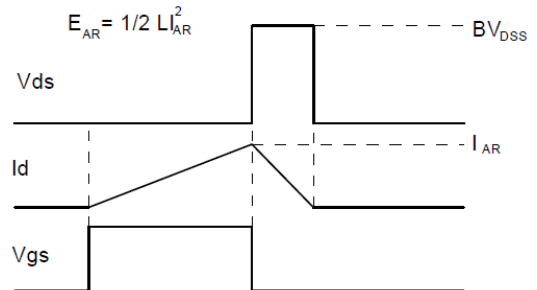

**Unclamped Inductive Switching (UIS) Test Circuit & Waveforms**



# YJQ30N03A

## DFN3333-8L Package information

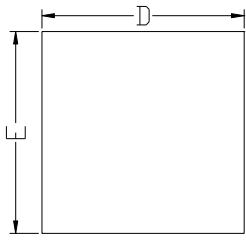

Top View  
正面视图

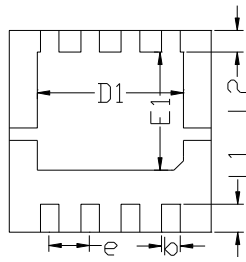

Bottom View  
背面视图

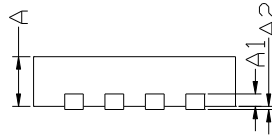

Side View  
侧面视图

SYMBOL	MILLIMETER		
	MIN	NOM	MAX
D	3.15	3.25	3.35
E	3.15	3.25	3.35
A	0.70	0.80	0.90
A1	0.20 BSC		
A2			0.10
D1	2.20	2.35	2.50
E1	1.80	1.90	2.00
L1	0.35	0.45	0.55
L2	0.35 BSC		
b	0.20	0.30	0.40
e	0.65 BSC		

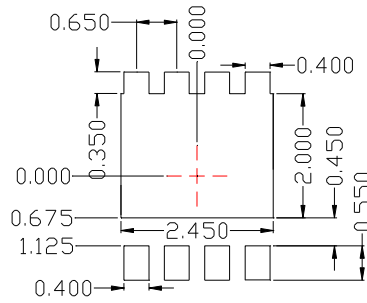

Suggested Solder Pad Layout  
Top View

Note:

1. Controlling dimension: in millimeters.
2. General tolerance:  $\pm 0.10\text{mm}$ .
3. The pad layout is for reference purposes only.



## YJQ30N03A

---

### Disclaimer

The information presented in this document is for reference only. Yangzhou Yangjie Electronic Technology Co., Ltd. reserves the right to make changes without notice for the specification of the products displayed herein to improve reliability, function or design or otherwise.

The product listed herein is designed to be used with ordinary electronic equipment or devices, and not designed to be used with equipment or devices which require high level of reliability and the malfunction of which would directly endanger human life (such as medical instruments, transportation equipment, aerospace machinery, nuclear-reactor controllers, fuel controllers and other safety devices), Yangjie or anyone on its behalf, assumes no responsibility or liability for any damages resulting from such improper use of sale.

This publication supersedes & replaces all information previously supplied. For additional information, please visit our website [http:// www.21yangjie.com](http://www.21yangjie.com) , or consult your nearest Yangjie's sales office for further assistance.