

## P-Channel Enhancement Mode Field Effect Transistor

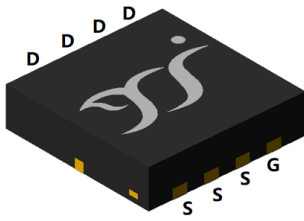

Top View

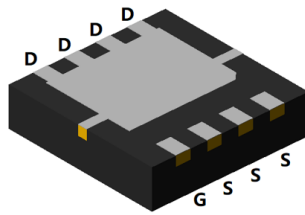

Bottom View

**DFN3333-8L**

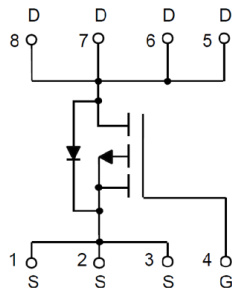

### Product Summary

- $V_{DS}$  -100V
- $I_D$  -15A
- $R_{DS(ON)}$  (at  $V_{GS}=-10V$ ) <110 mohm
- $R_{DS(ON)}$  (at  $V_{GS}=-4.5V$ ) <120 mohm
- 100% EAS Tested

### General Description

- Split gate trench MOSFET technology
- Excellent package for heat dissipation
- High density cell design for low  $R_{DS(ON)}$
- Moisture Sensitivity Level 3
- Epoxy Meets UL 94 V-0 Flammability Rating
- Halogen Free

### Applications

- DC-DC Converters
- Power management functions

### ■ Absolute Maximum Ratings ( $T_A=25^\circ C$ unless otherwise noted)

Parameter		Symbol	Limit	Unit
Drain-source Voltage		$V_{DS}$	-100	V
Gate-source Voltage		$V_{GS}$	$\pm 20$	V
Drain Current	$T_A=25^\circ C$	$I_D$	-4.5	A
	$T_A=100^\circ C$		-2.8	
	$T_C=25^\circ C$		-15	
	$T_C=100^\circ C$		-9.5	
Pulsed Drain Current <sup>A</sup>		$I_{DM}$	-45	A
Avalanche energy <sup>B</sup>		EAS	64	mJ
Total Power Dissipation <sup>C</sup>	$T_A=25^\circ C$	$P_D$	3	W
	$T_A=100^\circ C$		1.2	
	$T_C=25^\circ C$		43	
	$T_C=100^\circ C$		17.2	
Junction and Storage Temperature Range		$T_J, T_{STG}$	-55~+150	$^\circ C$

### ■ Thermal resistance

Parameter		Symbol	Typ	Max	Units
Thermal Resistance Junction-to-Ambient <sup>D</sup>	$t \leq 10S$	$R_{\theta JA}$	20	25	$^\circ C/W$
Thermal Resistance Junction-to-Ambient <sup>D</sup>	Steady-State		40	50	
Thermal Resistance Junction-to-Case	Steady-State	$R_{\theta JC}$	2.4	2.9	

### ■ Ordering Information (Example)

PREFERRED P/N	PACKING CODE	Marking	MINIMUM PACKAGE(pcs)	INNER BOX QUANTITY(pcs)	OUTER CARTON QUANTITY(pcs)	DELIVERY MODE
YJQ15GP10A	F1	Q15GP10A	5000	10000	100000	13" reel



# YJQ15GP10A

## ■ Electrical Characteristics (T<sub>J</sub>=25°C unless otherwise noted)

Parameter	Symbol	Conditions	Min	Typ	Max	Units
<b>Static Parameter</b>						
Drain-Source Breakdown Voltage	BV <sub>DSS</sub>	V <sub>GS</sub> =0V, I <sub>D</sub> =-250μA	-100			V
Zero Gate Voltage Drain Current	I <sub>DSS</sub>	V <sub>DS</sub> =-100V, V <sub>GS</sub> =0V	T <sub>J</sub> =25°C		-1	μA
			T <sub>J</sub> =55°C		-5	
Gate-Body Leakage Current	I <sub>GSS</sub>	V <sub>GS</sub> = ±20V, V <sub>DS</sub> =0V			±100	nA
Gate Threshold Voltage	V <sub>GS(th)</sub>	V <sub>DS</sub> = V <sub>GS</sub> , I <sub>D</sub> =-250μA	-1.0	-1.8	-2.5	V
Static Drain-Source On-Resistance	R <sub>DS(ON)</sub>	V <sub>GS</sub> = -10V, I <sub>D</sub> =-10A		83	110	mΩ
		V <sub>GS</sub> = -4.5V, I <sub>D</sub> =-5A		95	120	
Diode Forward Voltage	V <sub>SD</sub>	I <sub>S</sub> =-15A, V <sub>GS</sub> =0V			-1.3	V
Maximum Body-Diode Continuous Current	I <sub>S</sub>				-15	A
Gate resistance	R <sub>g</sub>	f=1MHz, Open drain		10		Ω
<b>Dynamic Parameters</b>						
Input Capacitance	C <sub>iss</sub>	V <sub>DS</sub> =-50V, V <sub>GS</sub> =0V, f=1MHZ		1051		pF
Output Capacitance	C <sub>oss</sub>			119		
Reverse Transfer Capacitance	C <sub>rss</sub>			25		
<b>Switching Parameters</b>						
Total Gate Charge	Q <sub>g(-10V)</sub>	V <sub>GS</sub> =-10V, V <sub>DS</sub> =-50V, I <sub>D</sub> =-5A		20.1		nC
Total Gate Charge	Q <sub>g(-4.5V)</sub>			9.7		
Gate-Source Charge	Q <sub>gs</sub>			3.98		
Gate-Drain Charge	Q <sub>gd</sub>			4.38		
Reverse Recovery Charge	Q <sub>rr</sub>	I <sub>F</sub> =-5A, di/dt=100A/us		140		nC
Reverse Recovery Time	t <sub>rr</sub>			80		
Turn-on Delay Time	t <sub>D(on)</sub>	V <sub>GS</sub> =-10V, V <sub>DD</sub> =-50V, I <sub>DS</sub> =-5A R <sub>GEN</sub> =6Ω		10		ns
Turn-on Rise Time	t <sub>r</sub>			30		
Turn-off Delay Time	t <sub>D(off)</sub>			77		
Turn-off fall Time	t <sub>f</sub>			81		

A. Repetitive rating; pulse width limited by max. junction temperature.

B. T<sub>J</sub>=25°C, V<sub>DD</sub>=-50V, V<sub>G</sub>=-10V, R<sub>G</sub>=25Ω, L=0.5mH, I<sub>AS</sub>=-16A.

C. Pd is based on max. junction temperature, using junction-case thermal resistance.

D. The value of RθJA is measured with the device mounted on 1in2 FR-4 board with 2oz. Copper, in a still air environment with TA =25° C. The Power dissipation PDSM is based on RθJA ≤ 10s and the maximum allowed junction temperature of 150° C. The value in any given application depends on the user's specific board design.



## ■ Typical Performance Characteristics

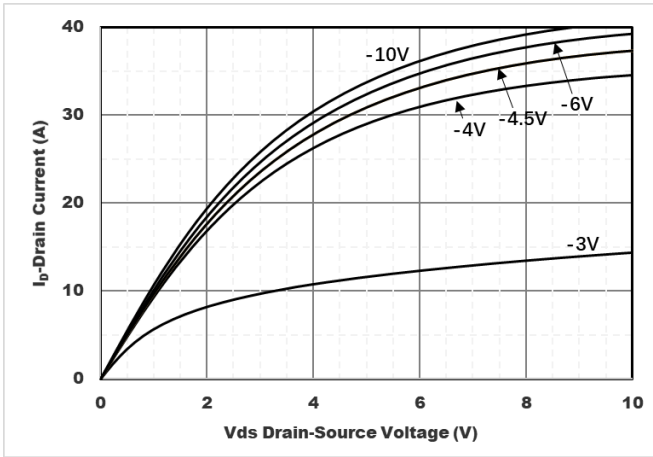

Figure1. Output Characteristics

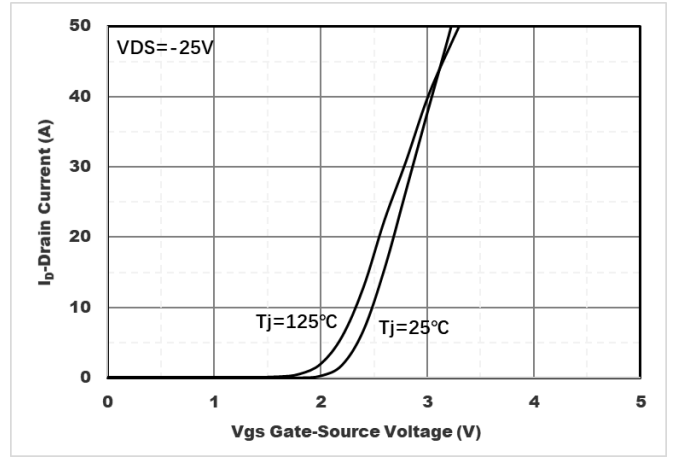

Figure2. Transfer Characteristics

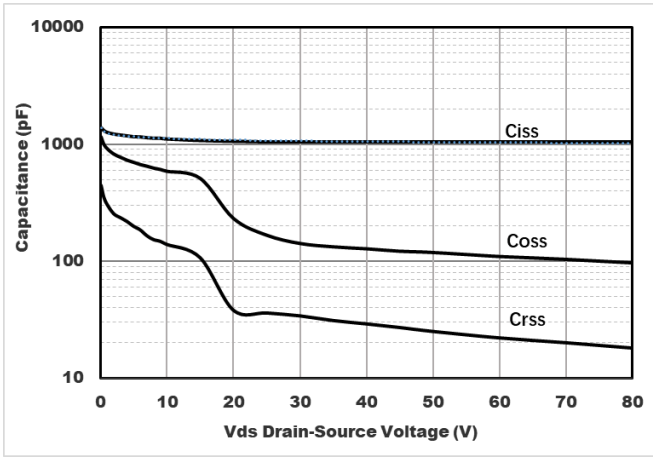

Figure3. Capacitance Characteristics

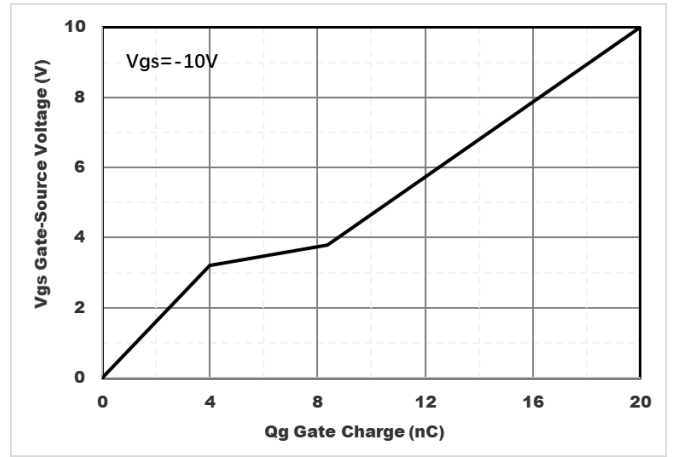

Figure4. Gate Charge

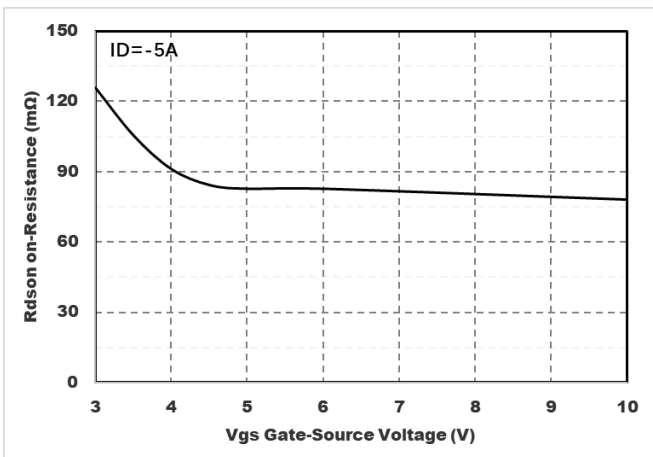

Figure5. : On-Resistance vs. Gate to Source Voltage

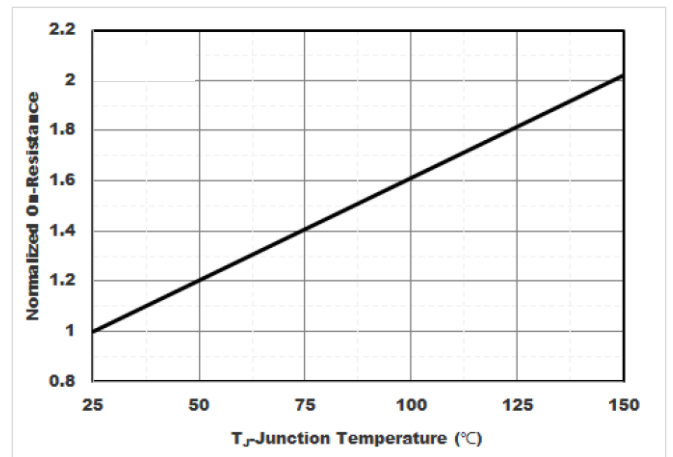

Figure6. Normalized On-Resistance



# YJQ15GP10A

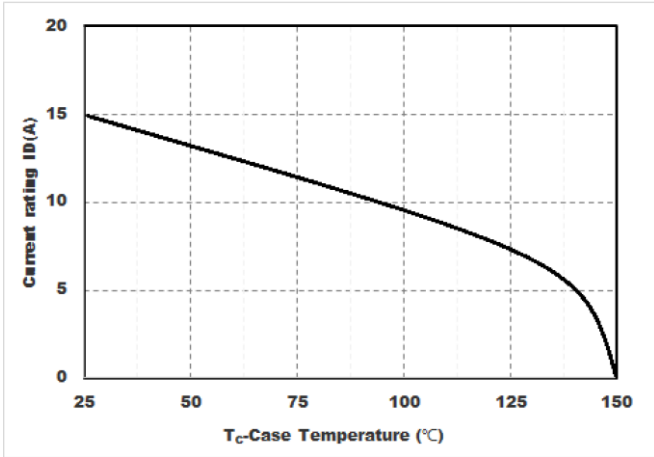

Figure7. Drain current

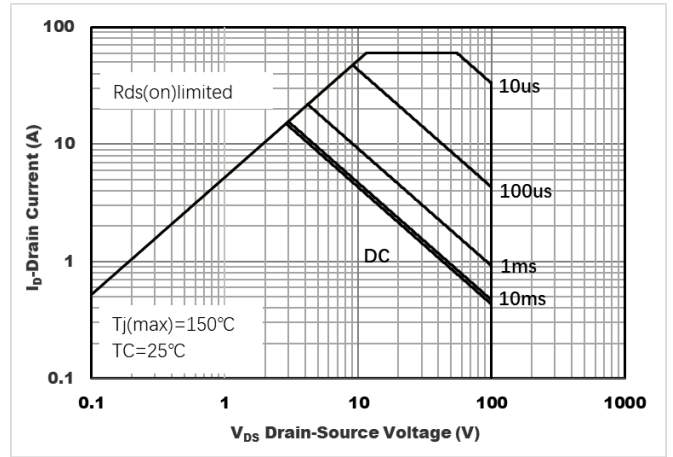

Figure8.Safe Operation Area

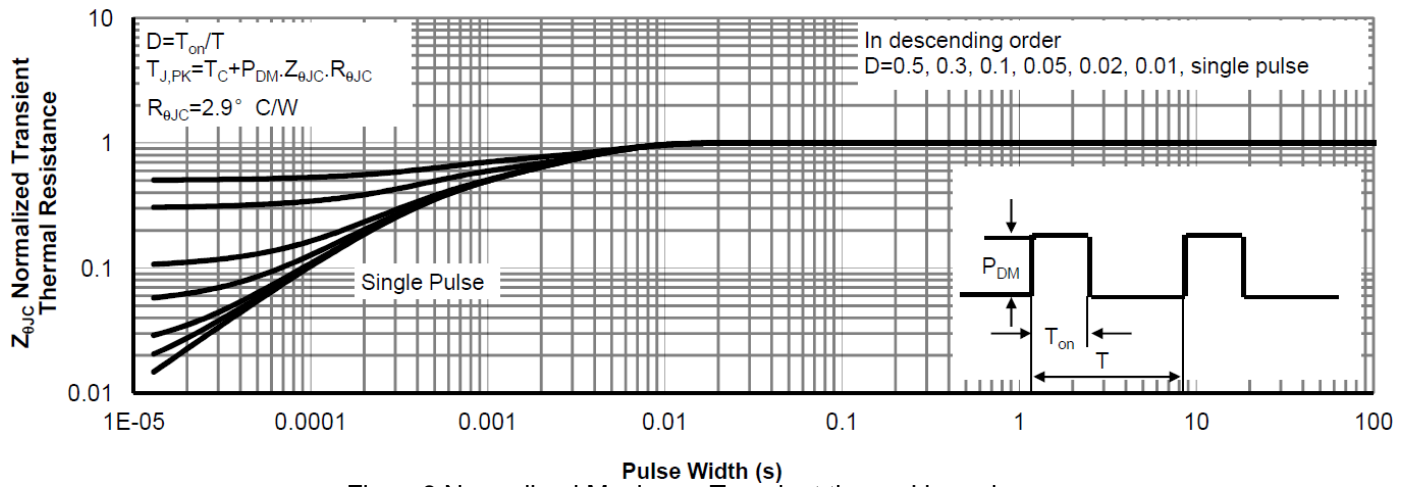
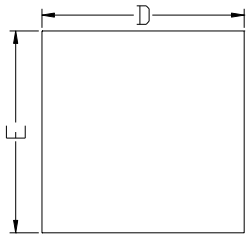

Figure9.Normalized Maximum Transient thermal impedance



# YJQ15GP10A

## ■ DFN3333-8L Package Information



Top View  
正面视图

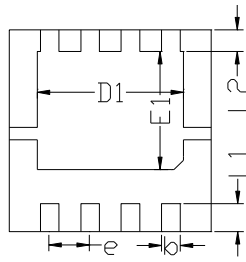

Bottom View  
背面视图

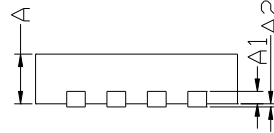

Side View  
侧面视图

SYMBOL	MILLIMETER		
	MIN	NOM	MAX
D	3.15	3.25	3.35
E	3.15	3.25	3.35
A	0.70	0.80	0.90
A1	0.20 BSC		
A2			0.10
D1	2.20	2.35	2.50
E1	1.80	1.90	2.00
L1	0.35	0.45	0.55
L2	0.35 BSC		
b	0.20	0.30	0.40
e	0.65 BSC		

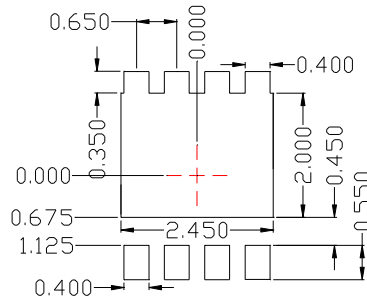

Suggested Solder Pad Layout  
Top View

Note:

1. Controlling dimension: in millimeters.
2. General tolerance:  $\pm 0.10\text{mm}$ .
3. The pad layout is for reference purposes only.



## YJQ15GP10A

---

### Disclaimer

The information presented in this document is for reference only. Yangzhou Yangjie Electronic Technology Co., Ltd. reserves the right to make changes without notice for the specification of the products displayed herein to improve reliability, function or design or otherwise.

The product listed herein is designed to be used with ordinary electronic equipment or devices, and not designed to be used with equipment or devices which require high level of reliability and the malfunction of which would directly endanger human life (such as medical instruments, transportation equipment, aerospace machinery, nuclear-reactor controllers, fuel controllers and other safety devices), Yangjie or anyone on its behalf, assumes no responsibility or liability for any damages resulting from such improper use of sale.

This publication supersedes & replaces all information previously supplied. For additional information, please visit our website [http:// www.21yangjie.com](http://www.21yangjie.com) , or consult your nearest Yangjie's sales office for further assistance.