

Schottky Rectifier

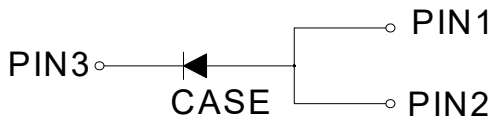
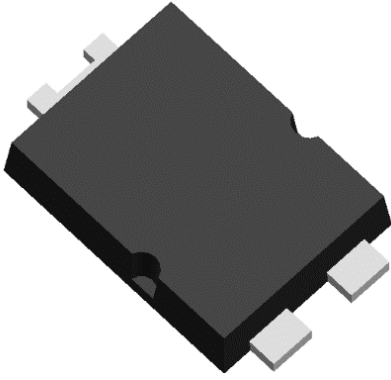

Features

- Ideal for automated placement
- Low power losses
- High forward surge capability
- Meets MSL level1, per J-STD-020, LF maximum peak of 260 °C
- Part no. with suffix "Q" means AEC-Q101 qualified

Typical Applications

For use in lighting, fast switching rectification of power suppliers, DC/AC inverters, DC/DC converters, and freewheeling diodes for polarity protection application for consumer, automotive and telecommunication.

Mechanical Data

- **Package:** TO-277
Molding compound meets UL 94 V-0 flammability rating, RoHS-compliant, Halogen free
- **Terminals:** Tin plated leads, solderable per J-STD-002 and JESD22-B102

■ Maximum Ratings ($T_a=25^\circ\text{C}$ Unless otherwise specified)

PARAMETER	SYMBOL	UNIT	SS5U100PAQ
Device marking code			SS5U100PA
Repetitive Peak Reverse Voltage	V_{RRM}	V	100
Average Rectified Output Current @60Hz -sine wave	I_o	A	5
Forward Surge Current (Non-repetitive) @60Hz Half-sine wave, 1 cycle, $T_a=25^\circ\text{C}$	I_{FSM}	A	200
Current Squared Time @1ms \leq t \leq 8.3ms $T_J=25^\circ\text{C}$	I^2t	A ² s	166
Non-repetitive avalanche energy at $I_{AS}=2.0$ A, $T_J = 25^\circ\text{C}$	E_{AS}	mJ	20
Storage Temperature	T_{stg}	$^\circ\text{C}$	-55 ~+175
Junction Temperature	T_J	$^\circ\text{C}$	-55 ~+175

■ Electrical Characteristics ($T_a=25^\circ\text{C}$ Unless otherwise specified)

PARAMETER	SYMBOL	UNIT	TEST CONDITIONS	Typ	Max	
Instantaneous forward voltage	V_F	V	$I_F=5.0\text{A}$	$T_A=25^\circ\text{C}$	0.725	0.8
				$T_A=125^\circ\text{C}$	0.585	0.68
Typical junction capacitance	C_J	pF	$V_R=4\text{V}$, $f=1$ MHz	270	-	
Leakage Current	I_R	μA	$V_R=100\text{V}$	$T_A=25^\circ\text{C}$	0.3	10
		mA		$T_A=125^\circ\text{C}$	0.3	3



SS5U100PAQ

■ Thermal Characteristics ($T_a=25^{\circ}\text{C}$ Unless otherwise specified)

PARAMETER	SYMBOL	UNIT	SS5U100PAQ
Typical Thermal Resistance	$R_{\theta J-A}$	$^{\circ}\text{C}/\text{W}$	65
	$R_{\theta J-L}$	$^{\circ}\text{C}/\text{W}$	3

■ Ordering Information (Example)

PREFERRED P/N	PACKAGE CODE	UNIT WEIGHT(g)	MINIMUM PACKAGE(pcs)	INNER BOX QUANTITY(pcs)	OUTER CARTON QUANTITY(pcs)	DELIVERY MODE
SS5U100PAQ	F1	Approximate 0.0821	5000	10000	80000	13" reel

■ Characteristics (Typical)

Fig.1:Forward Current Derating Curve

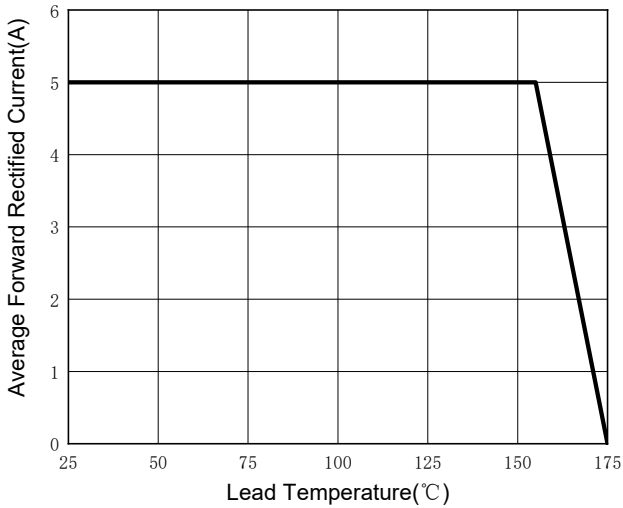

Fig.2:Forward Surge Current Capability

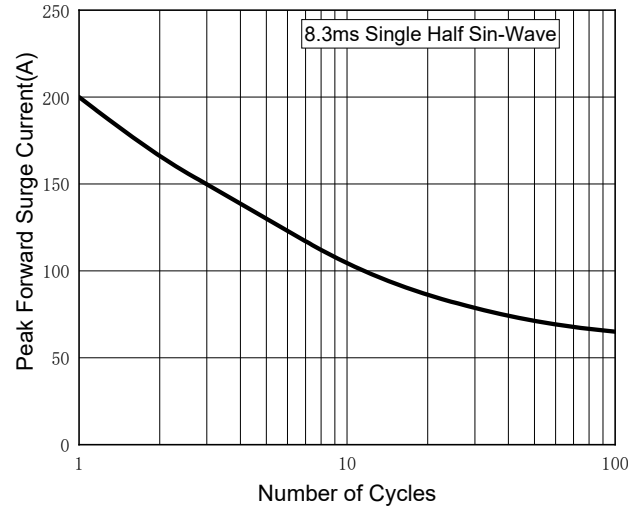

Fig.3:Typical Instantaneous Forward Characteristics

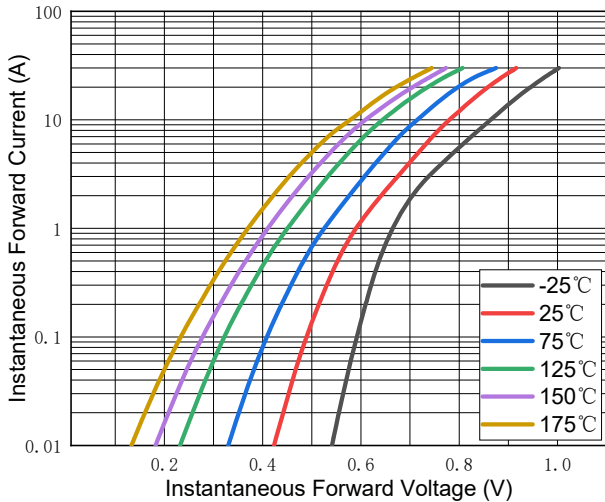
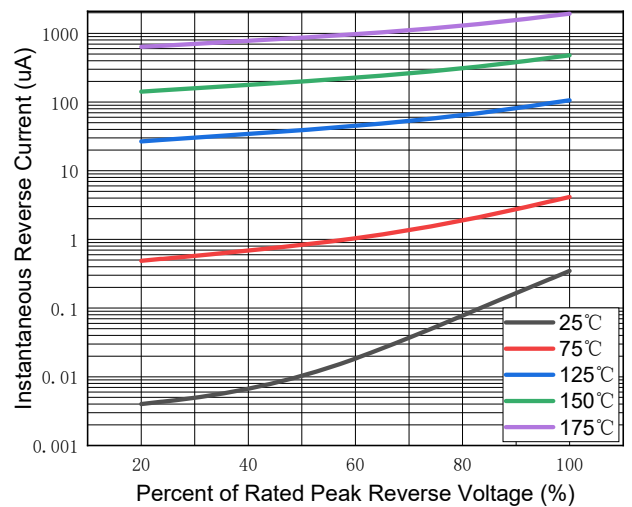

Fig.4:Typical Reverse Characteristics





SS5U100PAQ

■ Outline Dimensions

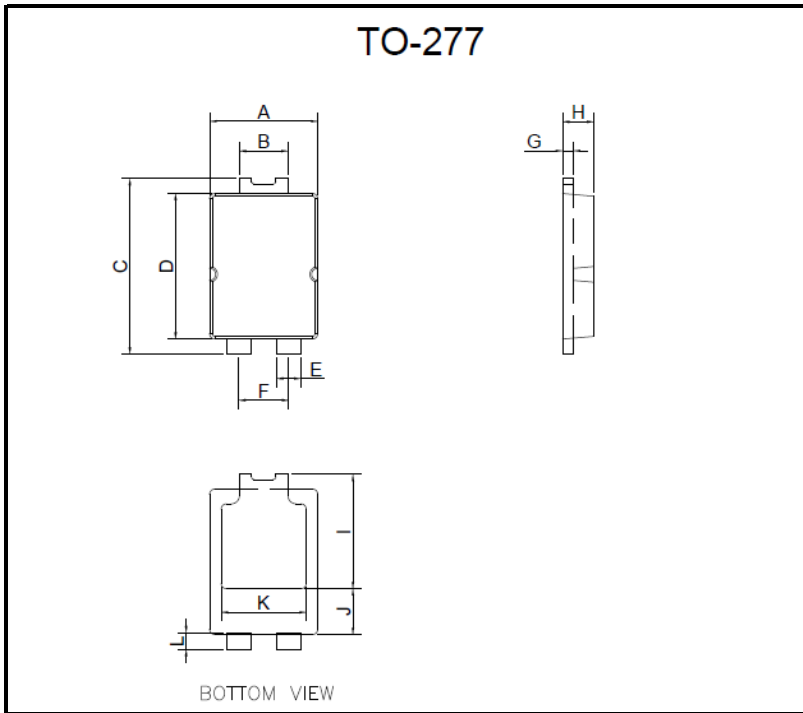

DIM	mm	
	MIN.	MAX.
A	3.90	4.10
B	1.70	1.90
C	6.40	6.60
D	5.30	5.50
E	0.80	1.00
F	1.85 REF	
G	0.35	0.45
H	1.10	1.20
I	4.10	4.50
J	1.50	1.90
K	2.90	3.40
L	0.55	0.75

■ Suggested pad layout

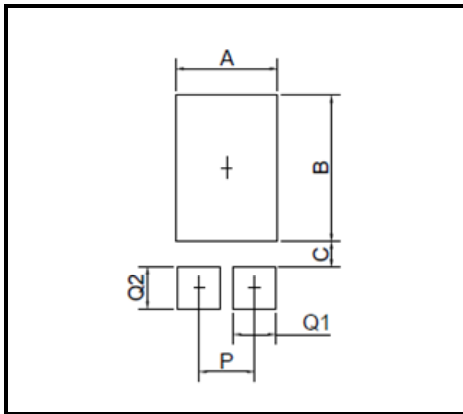

DIM	MIN.(mm)
A	3.36
B	4.86
C	0.85
P	1.84
Q1	1.40
Q2	1.40



SS5U100PAQ

Disclaimer

The information presented in this document is for reference only. Yangzhou Yangjie Electronic Technology Co., Ltd. reserves the right to make changes without notice for the specification of the products displayed herein to improve reliability, function or design or otherwise.

The product listed herein is designed to be used with automotive electronics, are not designed for use in medical, life-saving, lifesustaining, or military, Yangjie or anyone on its behalf, assumes no responsibility or liability for any damages resulting from such improper use of sale.

This publication supersedes & replaces all information previously supplied. For additional information, please visit our website [http:// www.21yangjie.com](http://www.21yangjie.com) , or consult your nearest Yangjie's sales office for further assistance.