

NPN General Purpose Amplifier

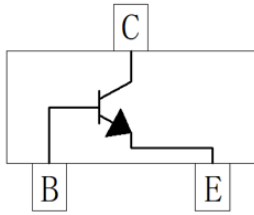

SOT-23

Features

- Epoxy meets UL-94 V-0 flammability rating and halogen free
- Moisture Sensitivity Level 1
- High Voltage Transistors NPN Silicon
- Part no. with suffix "Q" means AEC-Q101 qualified

Applications

- Linear amplification

Mechanical Data

- **Case:** SOT-23
- **Terminals:** Tin plated leads, solderable per J-STD-002 and JESD22-B102
- **Marking:** G1

■ Maximum Ratings (Ta=25°C unless otherwise noted)

| Item | Symbol | Unit | Conditions | Value |
|---|-----------------|------|------------|-------------|
| Collector-Base Voltage | V_{CBO} | V | | 180 |
| Collector-Emitter Voltage | V_{CEO} | V | | 160 |
| Emitter-Base Voltage | V_{EBO} | V | | 6.0 |
| Collector Current -Continuous | I_C | mA | | 600 |
| Total Device Dissipation (*) | P_D | mW | | 300 |
| Thermal Resistance From Junction To Ambient (*) | $R_{\theta JA}$ | °C/W | | 417 |
| Maximum Junction Temperature | T_J | °C | | 150 |
| Storage Temperature | T_{STG} | °C | | -55 to +150 |

(*) Device mounted on FR-4 PCB 1.0 x 1.0 x 0.06 inch.



MMBT5551Q

■ Electrical Characteristics (Ta=25°C unless otherwise noted)

| Item | Symbol | Unit | Conditions | Min | Max |
|--------------------------------------|---------------|------|--------------------------|-----|-----|
| Collector-base breakdown voltage | $V_{(BR)CBO}$ | V | $I_C=100\mu A, I_E=0$ | 180 | |
| Collector-emitter breakdown voltage | $V_{(BR)CEO}$ | V | $I_C=1.0mA, I_B=0$ | 160 | |
| Emitter-base breakdown voltage | $V_{(BR)EBO}$ | V | $I_E=10\mu A, I_C=0$ | 6.0 | |
| Collector cut-off current | I_{CBO} | nA | $V_{CB}=120V, I_E=0$ | | 50 |
| Emitter cut-off current | I_{EBO} | nA | $V_{EB}=4.0V, I_C=0$ | | 50 |
| DC current gain | h_{FE} | | $V_{CE}=5.0V, I_C=1.0mA$ | 80 | |
| | h_{FE} | | $V_{CE}=5.0V, I_C=10mA$ | 100 | 300 |
| | h_{FE} | | $V_{CE}=5.0V, I_C=50mA$ | 50 | |
| Collector-emitter saturation voltage | $V_{CE(sat)}$ | V | $I_C=50mA, I_B=5.0mA$ | | 0.2 |
| Base-emitter saturation voltage | $V_{BE(sat)}$ | V | $I_C=50mA, I_B=5.0mA$ | | 1.0 |

■ Small-signal Characteristics

| Item | Symbol | Unit | Conditions | Min | Max |
|----------------------|--------|------|------------------------------------|-----|-----|
| Transition frequency | f_T | MHz | $V_{CE}=5.0Vdc, I_C=10mA, f=30MHz$ | 100 | 300 |

■ Ordering Information (Example)

| PREFERRED P/N | PACKING CODE | UNIT WEIGHT(g) | MINIMUM PACKAGE(pcs) | INNER BOX QUANTITY(pcs) | OUTER CARTON QUANTITY(pcs) | DELIVERY MODE |
|---------------|--------------|------------------|----------------------|-------------------------|----------------------------|---------------|
| MMBT5551Q | F2 | Approximate 0.01 | 3000 | 30000 | 120000 | 7" reel |

■ Characteristics (Typical)

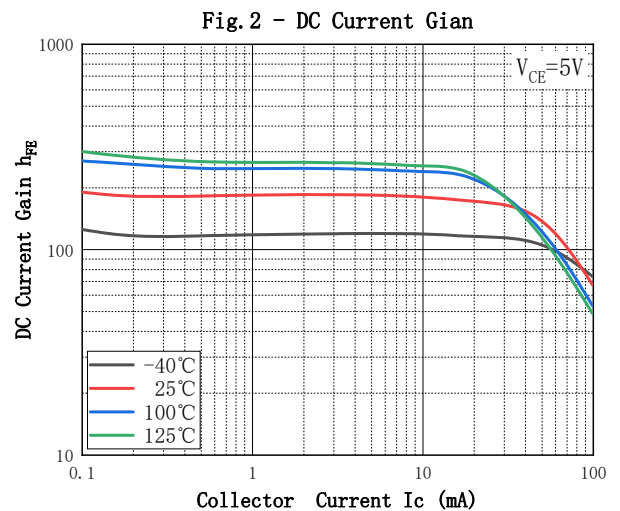
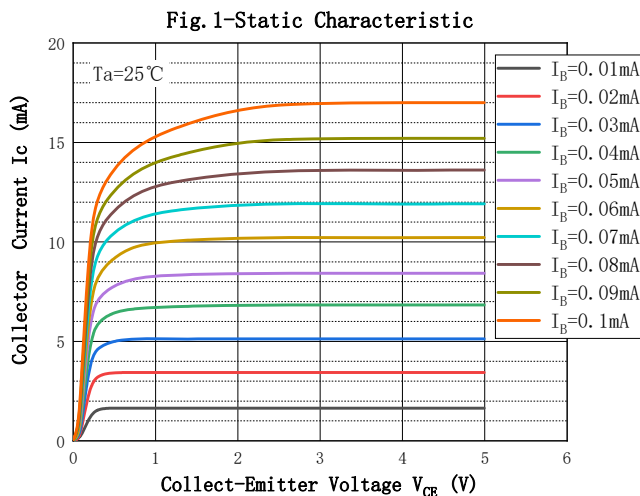



MMBT5551Q

Fig. 3 - Collect-Emmitter Saturation Voltage

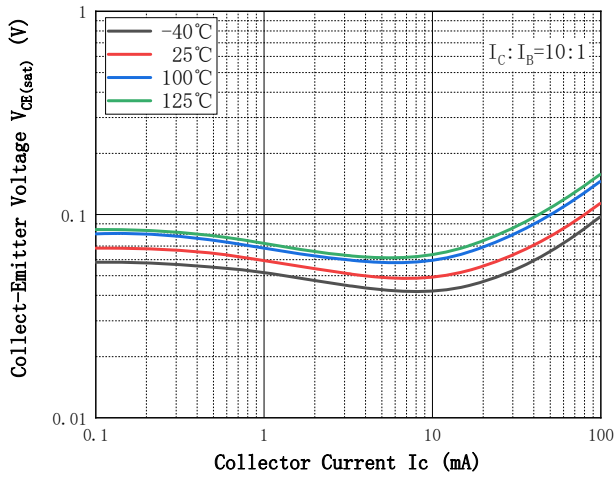

Fig. 4 - Base-Emmitter Voltage

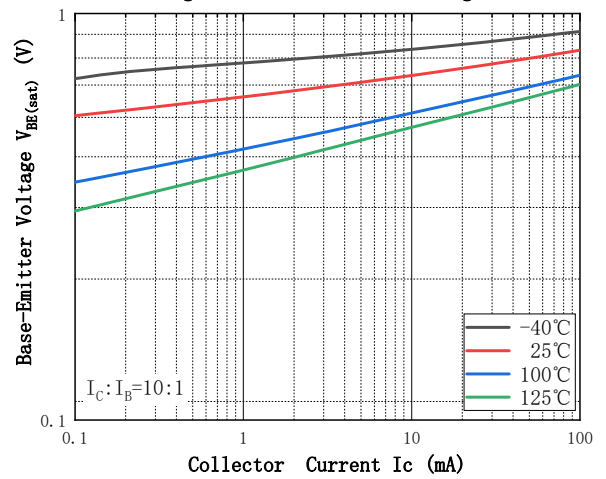

Fig. 5 - Base-Emmitter On Voltage

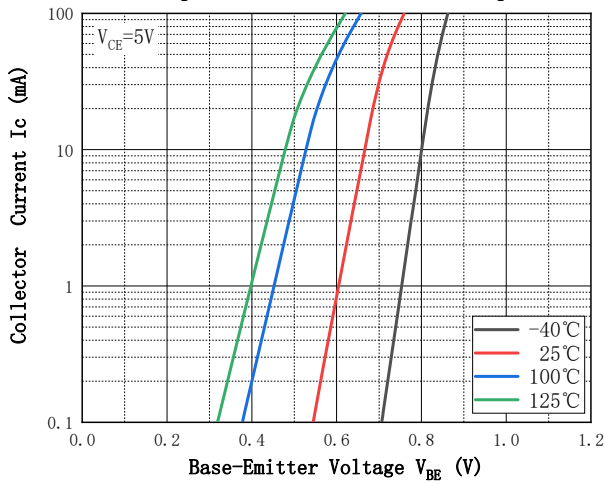
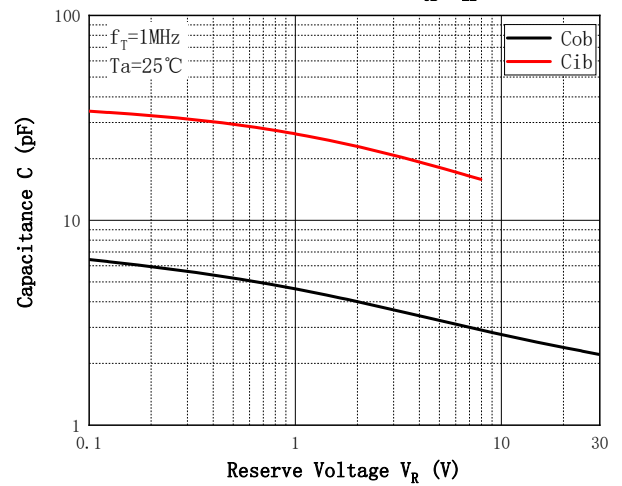
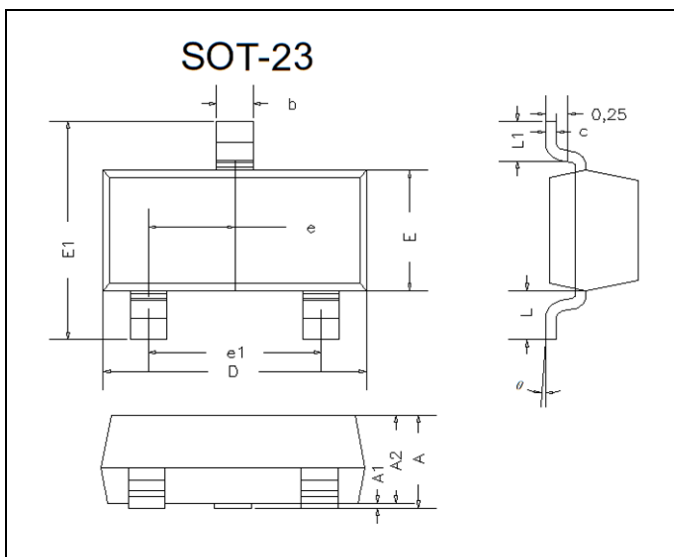

Fig. 6 - Cob/Cib—V_CE/V_BE



■SOT-23 Package Outline Dimensions



| DIM | INCHES | | MM | | NOTE |
|-----|----------|-------|---------|------|------|
| | MIN | MAX | MIN | MAX | |
| A | 0.035 | 0.045 | 0.90 | 1.15 | |
| A1 | 0.000 | 0.004 | 0.00 | 0.10 | |
| A2 | 0.035 | 0.041 | 0.90 | 1.05 | |
| b | 0.012 | 0.020 | 0.30 | 0.50 | |
| c | 0.004 | 0.008 | 0.10 | 0.20 | |
| D | 0.110 | 0.118 | 2.80 | 3.00 | |
| E | 0.047 | 0.055 | 1.20 | 1.40 | |
| E1 | 0.089 | 0.100 | 2.25 | 2.55 | |
| e | 0.370TYP | | 0.95TYP | | |
| e1 | 0.071 | 0.079 | 1.80 | 2.00 | |
| L | 0.220REF | | 0.55REF | | |
| L1 | 0.012 | 0.020 | 0.30 | 0.50 | |
| θ | 0° | 8° | 0° | 8° | |



■SOT-23 Suggested Pad Layout

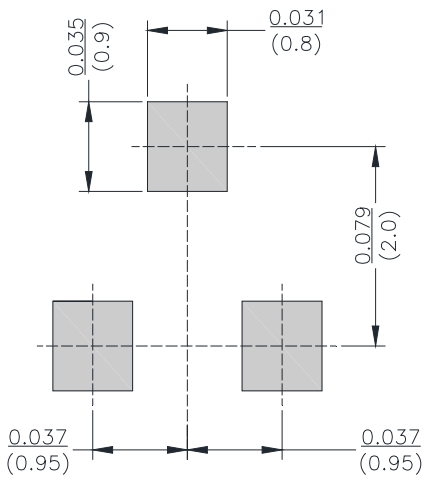

Unit: $\frac{\text{inch}}{\text{mm}}$



MMBT5551Q

Disclaimer

The information presented in this document is for reference only. Yangzhou Yangjie Electronic Technology Co., Ltd. reserves the right to make changes without notice for the specification of the products displayed herein to improve reliability, function or design or otherwise.

The product listed herein is designed to be used with automotive electronics, are not designed for use in medical, life-saving, lifesustaining, or military, Yangjie or anyone on its behalf, assumes no responsibility or liability for any damages resulting from such improper use of sale.

This publication supersedes & replaces all information previously supplied. For additional information, please visit our website [http:// www.21yangjie.com](http://www.21yangjie.com) , or consult your nearest Yangjie's sales office for further assistance.