

IGBT Modules

V _{CES}	1200V
I _C	25A

Applications

- Motor Drivers
- AC and DC servo drive amplifier
- UPS (Uninterruptible Power Supplies)

Features

- Low switching losses
- Low V_{ce(sat)} with positive temperature coefficient
- Including fast & soft recovery anti-parallel FWD
- Low inductance case
- High short circuit capability(10us)
- Isolated heatsink using DBC technology
- Maximum junction temperature 175°C

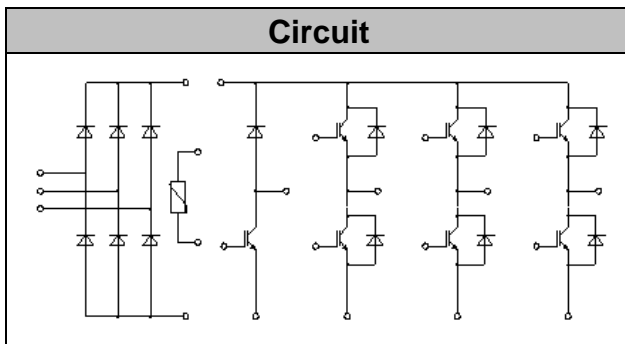

● IGBT- inverter

Absolute Maximum Ratings

Parameter	Symbol	Conditions	Value	Unit
Collector-Emitter Voltage	V _{CES}	V _{GE} =0V, I _C =1mA, T _{vj} =25°C	1200	V
Continuous Collector Current	I _C	T _c =100°C, T _{vjmax} =175°C	25	A
Repetitive Peak Collector Current	I _{CRM}	tp=1ms	50	A
Gate-Emitter Voltage	V _{GES}	T _{vj} =25°C	±20	V
Total Power Dissipation	P _{tot}	T _c =25°C T _{vjmax} =175°C	175	W



● IGBT- inverter

Characteristic values

Parameter	Symbol	Conditions	Value			Unit	
			Min.	Typ.	Max.		
Gate-emitter Threshold Voltage	$V_{GE(th)}$	$V_{GE}=V_{CE}, I_C=1.2mA, T_{vj}=25^{\circ}C$	5.2	5.8	6.4	V	
Collector-Emitter Cut-off Current	I_{CES}	$V_{CE}=1200V, V_{GE}=0V, T_{vj}=25^{\circ}C$			1.0	mA	
Collector-Emitter Saturation Voltage	$V_{CE(sat)}$	$I_C=25A, V_{GE}=15V, T_{vj}=25^{\circ}C$		1.85	2.25	V	
		$I_C=25A, V_{GE}=15V, T_{vj}=125^{\circ}C$		2.15			
		$I_C=25A, V_{GE}=15V, T_{vj}=150^{\circ}C$		2.25			
Gate Charge	Q_G			0.20		uC	
Input Capacitance	C_{ies}	$V_{CE}=25V, V_{GE}=0V,$ $f=1MHz, T_{vj}=25^{\circ}C$		1.90		nF	
Reverse Transfer Capacitance	C_{res}			0.10		nF	
Gate-Emitter leakage current	I_{GES}	$V_{CE}=0V, V_{GE}=20V, T_{vj}=25^{\circ}C$			400	nA	
Turn-on Delay Time	$t_{d(on)}$	$I_C=25A$ $V_{CE}=600V$ $V_{GE}=\pm 15V$ $R_G=20\Omega$ $T_{vj}=25^{\circ}C$		26		ns	
Rise Time	t_r			17		ns	
Turn-off Delay Time	$t_{d(off)}$			194		ns	
Fall Time	t_f			181		ns	
Energy Dissipation During Turn-on Time	E_{on}				1.62		mJ
Energy Dissipation During Turn-off Time	E_{off}				1.44		mJ
Turn-on Delay Time	$t_{d(on)}$		$I_C=25A$ $V_{CE}=600V$ $V_{GE}=\pm 15V$ $R_G=20\Omega$ $T_{vj}=125^{\circ}C$		28		ns
Rise Time	t_r				21		ns
Turn-off Delay Time	$t_{d(off)}$				284		ns
Fall Time	t_f				212		ns
Energy Dissipation During Turn-on Time	E_{on}				2.4		mJ
Energy Dissipation During Turn-off Time	E_{off}				2.18		mJ
SC Data	I_{sc}	$T_p \leq 10\mu s, V_{GE}=15V, T_{vj}=150^{\circ}C,$ $V_{cc}=900V, V_{CEM} \leq 1200V$			120		A



● Diode-inverter

Absolute Maximum Ratings

Parameter	Symbol	Conditions	Value	Unit
Repetitive Peak Reverse Voltage	V_{RRM}	$T_{vj}=25^{\circ}C$	1200	V
Continuous DC Forward Current	I_F		25	A
Repetitive Peak Forward Current	I_{FRM}	$t_p=1ms$	50	A
I^2t -value	I^2t	$V_R=0, t_p=10ms, T_{vj}=125^{\circ}C$	90.0	A ² s
		$V_R=0, t_p=10ms, T_{vj}=150^{\circ}C$	75.0	

Characteristic values

Parameter	Symbol	Conditions	Value			Unit
			Min.	Typ.	Max.	
Forward Voltage	V_F	$I_F=25A, T_{vj}=25^{\circ}C$		2.10	2.50	V
		$I_F=25A, T_{vj}=125^{\circ}C$		2.20		
		$I_F=25A, T_{vj}=150^{\circ}C$		2.20		
Recovered Charge	Q_{rr}	$I_F=25A$		2.52		μC
Peak Reverse Recovery Current	I_{rr}	$V_R=600V$ $-di_F/dt=1700A/\mu s$		28.5		A
Reverse Recovery Energy	E_{rec}	$T_{vj}=25^{\circ}C$		0.94		mJ
Recovered Charge	Q_{rr}	$I_F=25A$		50.8		μC
Peak Reverse Recovery Current	I_{rr}	$V_R=600V$ $-di_F/dt=1700A/\mu s$		30.5		A
Reverse Recovery Energy	E_{rec}	$T_{vj}=125^{\circ}C$		1.75		mJ



● **IGBT-brake-chopper**
Absolute Maximum Ratings

Parameter	Symbol	Conditions	Value	Unit
Collector-Emitter Voltage	V_{CES}	$V_{GE}=0V, I_C=1mA, T_{vj}=25^{\circ}C$	1200	V
Continuous Collector Current	I_C	$T_c=100^{\circ}C, T_{vjmax}=175^{\circ}C$	25	A
Repetitive Peak Collector Current	I_{CRM}	$t_p=1ms$	50	A
Gate-Emitter Voltage	V_{GES}	$T_{vj}=25^{\circ}C$	± 20	V
Total Power Dissipation	P_{tot}	$T_c=25^{\circ}C, T_{vjmax}=175^{\circ}C$	175	W

Characteristic values

Parameter	Symbol	Conditions	Value			Unit	
			Min.	Typ.	Max.		
Gate-emitter Threshold Voltage	$V_{GE(th)}$	$V_{GE}=V_{CE}, I_C=1.2mA, T_{vj}=25^{\circ}C$	5.2	5.8	6.4	V	
Collector-Emitter Cut-off Current	I_{CES}	$V_{CE}=1200V, V_{GE}=0V, T_{vj}=25^{\circ}C$			1.0	mA	
Collector-Emitter Saturation Voltage	$V_{CE(sat)}$	$I_C=25A, V_{GE}=15V, T_{vj}=25^{\circ}C$		1.85	2.25	V	
		$I_C=25A, V_{GE}=15V, T_{vj}=125^{\circ}C$		2.15			
		$I_C=25A, V_{GE}=15V, T_{vj}=150^{\circ}C$		2.25			
Gate Charge	Q_G			0.20		uC	
Input Capacitance	C_{ies}	$V_{CE}=25V, V_{GE}=0V,$ $f=1MHz, T_{vj}=25^{\circ}C$		1.90		nF	
Reverse Transfer Capacitance	C_{res}			0.10		nF	
Gate-Emitter leakage current	I_{GES}	$V_{CE}=0V, V_{GE}=20V, T_{vj}=25^{\circ}C$			400	nA	
Turn-on Delay Time	$t_{d(on)}$	$I_C=25A$ $V_{CE}=600V$ $V_{GE}=\pm 15V$ $R_G=20\Omega$ $T_{vj}=25^{\circ}C$		26		ns	
Rise Time	t_r			17		ns	
Turn-off Delay Time	$t_{d(off)}$			194		ns	
Fall Time	t_f			181		ns	
Energy Dissipation During Turn-on Time	E_{on}				1.62		mJ
Energy Dissipation During Turn-off Time	E_{off}				1.44		mJ



Turn-on Delay Time	$t_{d(on)}$	$I_C = 25\text{ A}$ $V_{CE} = 600\text{ V}$ $V_{GE} = \pm 15\text{ V}$ $R_G = 20\Omega$ $T_{vj} = 125^\circ\text{C}$		28	ns
Rise Time	t_r		21	ns	
Turn-off Delay Time	$t_{d(off)}$		284	ns	
Fall Time	t_f		212	ns	
Energy Dissipation During Turn-on Time	E_{on}		2.4	mJ	
Energy Dissipation During Turn-off Time	E_{off}		2.18	mJ	
SC Data	I_{sc}		$T_p \leq 10\mu\text{s}, V_{GE} = 15\text{ V}, T_{vj} = 150^\circ\text{C},$ $V_{cc} = 900\text{ V}, V_{CEM} \leq 1200\text{ V}$	120	A

● Diode-Brake-Chopper

Absolute Maximum Ratings

Parameter	Symbol	Conditions	Value	Unit
Repetitive Peak Reverse Voltage	V_{RRM}	$T_{vj} = 25^\circ\text{C}$	1200	V
Continuous DC Forward Current	I_F		15	A
Repetitive Peak Forward Current	I_{FRM}	$t_p = 1\text{ ms}$	30	A
I^2t -value	I^2t	$V_R = 0, t_p = 10\text{ ms}, T_{vj} = 125^\circ\text{C}$	16.0	A ² s
		$V_R = 0, t_p = 10\text{ ms}, T_{vj} = 150^\circ\text{C}$	14.0	

Characteristic values

Parameter	Symbol	Conditions	Value			Unit
			Min.	Typ.	Max.	
Forward Voltage	V_F	$I_F = 15\text{ A}, T_{vj} = 25^\circ\text{C}$		2.00	2.65	V
		$I_F = 15\text{ A}, T_{vj} = 125^\circ\text{C}$		2.10		
		$I_F = 15\text{ A}, T_{vj} = 150^\circ\text{C}$		2.10		
Recovered Charge	Q_{rr}	$I_F = 15\text{ A}$		1.20		uC
Peak Reverse Recovery Current	I_{rr}	$V_R = 600\text{ V}$ $-di_F/dt = 600\text{ A/us}$		13.0		A
Reverse Recovery Energy	E_{rec}	$T_{vj} = 25^\circ\text{C}$		0.37		mJ
Recovered Charge	Q_{rr}	$I_F = 15\text{ A}$		2.05		uC
Peak Reverse Recovery Current	I_{rr}	$V_R = 600\text{ V}$ $-di_F/dt = 600\text{ A/us}$		12.0		A
Reverse Recovery Energy	E_{rec}	$T_{vj} = 125^\circ\text{C}$		0.68		mJ



● Diode-Rectifier

Absolute Maximum Ratings

Parameter	Symbol	Conditions	Value	Unit
Repetitive Peak Reverse Voltage	V_{RRM}	$T_j=25^{\circ}\text{C}$	1600	V
Average output Current 50/60Hz, sine wave	$I_{F(AV)}$	$T_c=100^{\circ}\text{C}$	35	A
Maximum RMS Current at Rectifier Output	I_{RMSM}	$T_c=100^{\circ}\text{C}$	60	A
Surge Forward Current	I_{FSM}	$V_R=0, t_p=10\text{ms}, T_j=45^{\circ}\text{C}$	320	A
I^2t -value	I^2t	$V_R=0, t_p=10\text{ms}, T_j=45^{\circ}\text{C}$	510	A^2s

Characteristic values

Parameter	Symbol	Conditions	Value			Unit
			Min.	Typ.	Max.	
Diode Forward Voltage	V_F	$I_F=10\text{A}, T_j=150^{\circ}\text{C}$		1.02		V
Reverse Current	I_R	$T_j=150^{\circ}\text{C}, V_R=1600\text{V}$			2	mA

● NTC-Thermistor

Characteristic values

Parameter	Symbol	Conditions	Value			Unit
			Min.	Typ.	Max.	
Rated Resistance	R_{25}			5.0		$\text{k}\Omega$
Deviation of R_{100}	$\Delta R/R$	$T_c=100, R_{100}=493.3\Omega$	-5		5	%
Power Dissipation	P_{25}				20.0	mW
B-value	$B_{25/50}$	$R_2=R_{25}\exp[B_{25/50}(1/T_2-1/(298.15\text{K}))]$		3375		K



● Module Characteristics

$T_C=25^{\circ}\text{C}$ unless otherwise specified

Parameter	Symbol	Conditions	Value			Unit
			Min.	Typ.	Max.	
Isolation voltage	V_{isol}	$t=1\text{min}, f=50\text{Hz}$	2500			V
Maximum Junction Temperature	T_{jmax}				175	$^{\circ}\text{C}$
Operating Junction Temperature	T_{vjop}		-40		150	$^{\circ}\text{C}$
Storage Temperature	T_{stg}		-40		125	$^{\circ}\text{C}$
Stray-inductance-module	L_{SCE}			30		nH
Module lead resistance, terminals-chip	$R_{\text{CC}'+\text{EE}'}$	$T_C=25^{\circ}\text{C}$, per switch		5.00		m Ω
	$R_{\text{AA}'+\text{CC}'}$			6.00		
Thermal Resistance Junction-to Case	$R_{\theta\text{JC}}$	per IGBT-inverter		0.75	0.85	K/W
		per Diode-inverter		1.10	1.20	
		per IGBT-brake-copper		0.75	0.85	
		per Diode-chopper		1.30	1.45	
		per Diode-rectifier		0.90	1.25	
Thermal Resistance Case-to Sink	$R_{\theta\text{CS}}$	per IGBT-inverter		0.70		K/W
		per Diode-inverter		0.90		
		per IGBT-brake-copper		0.70		
		per Diode-chopper		1.05		
		per Diode-rectifier		0.95		
		per Module		0.037		
Mounting Force Per Clamp	F		30		80	N
Weight of Module	G			45		g

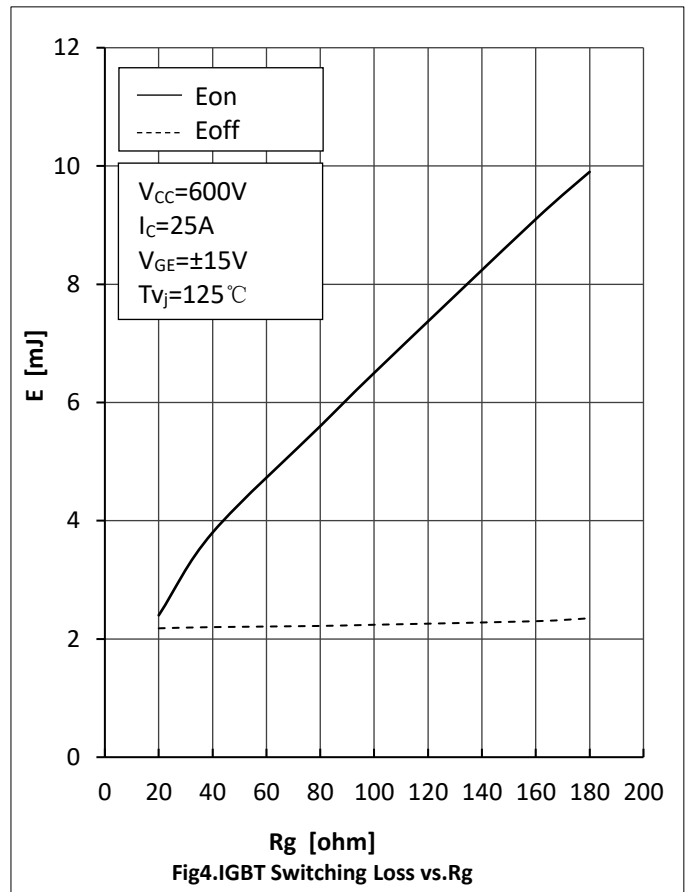
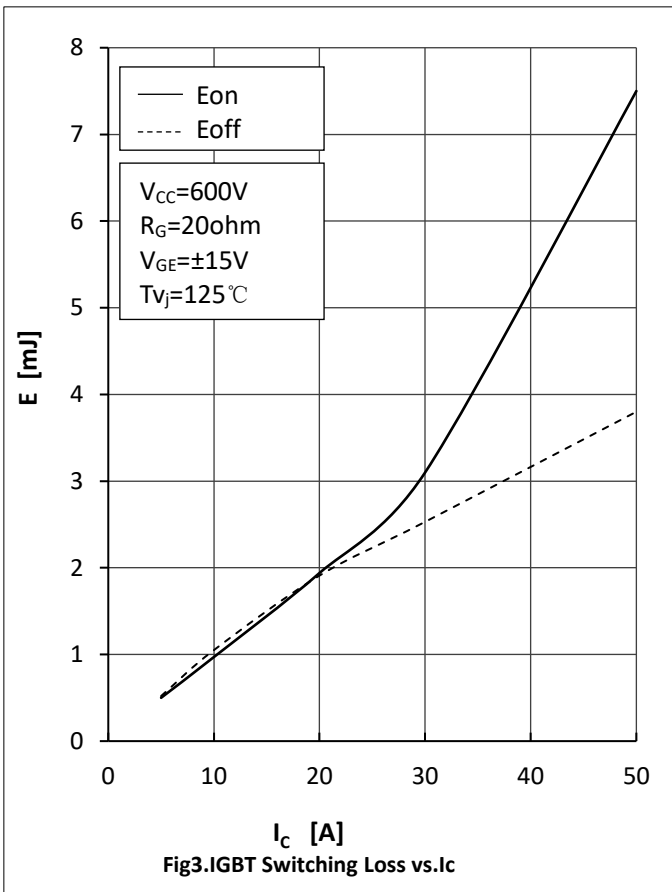
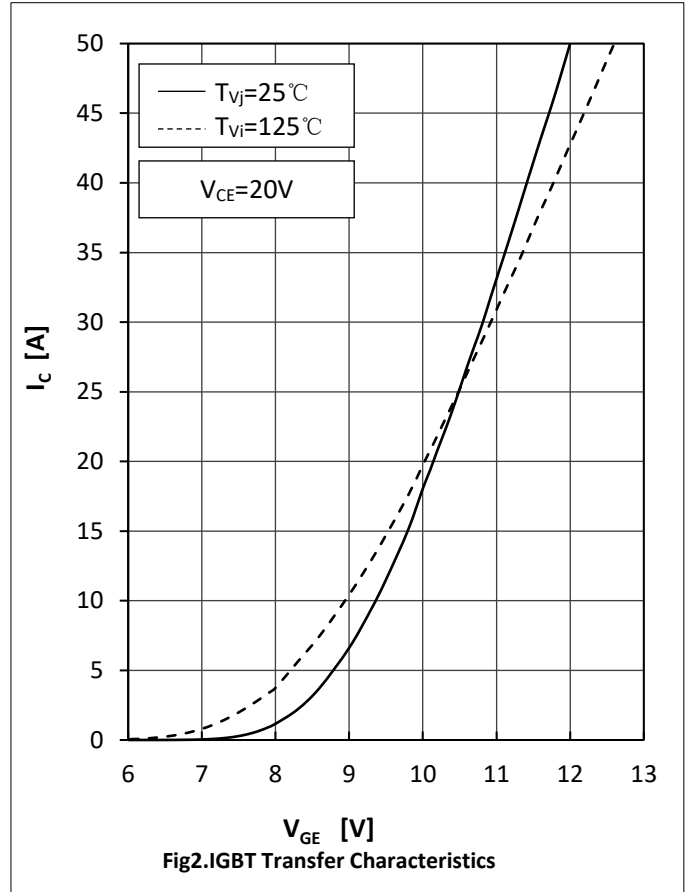
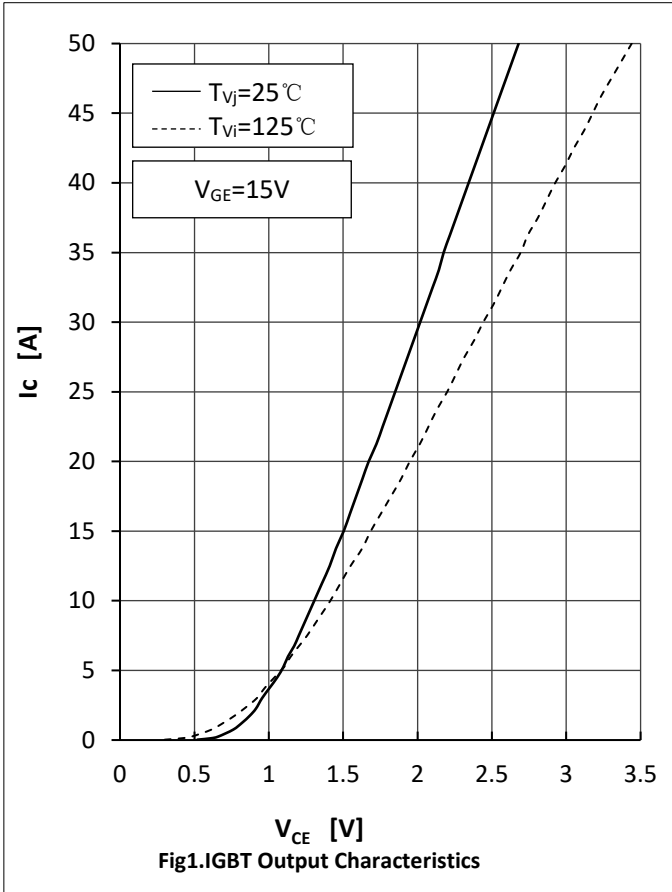

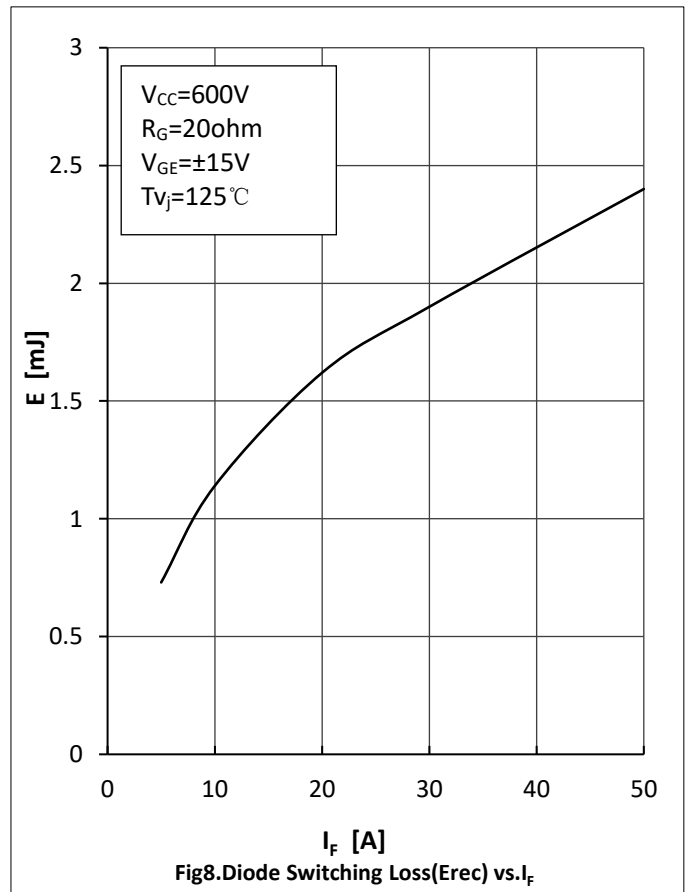
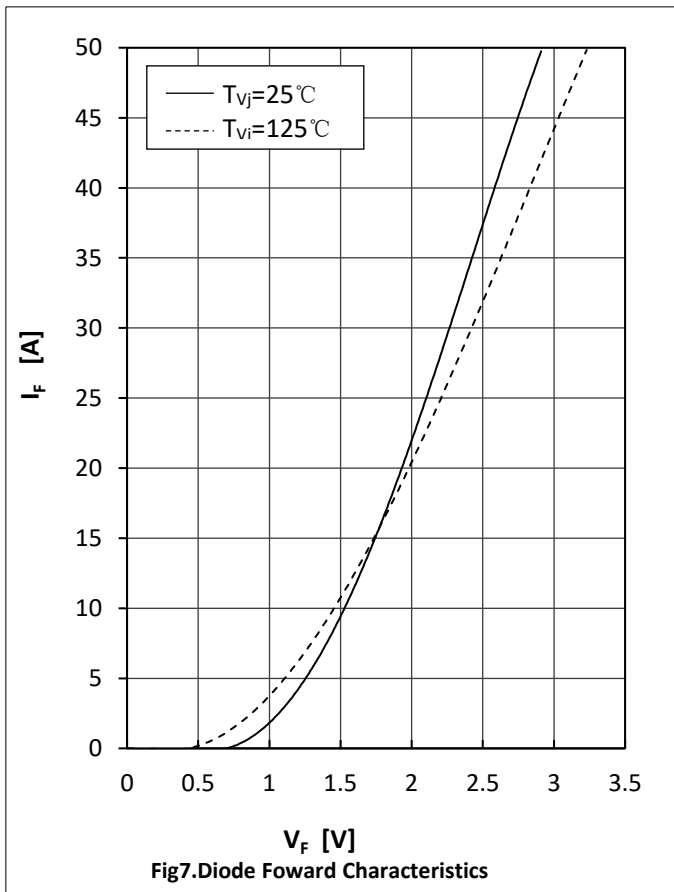
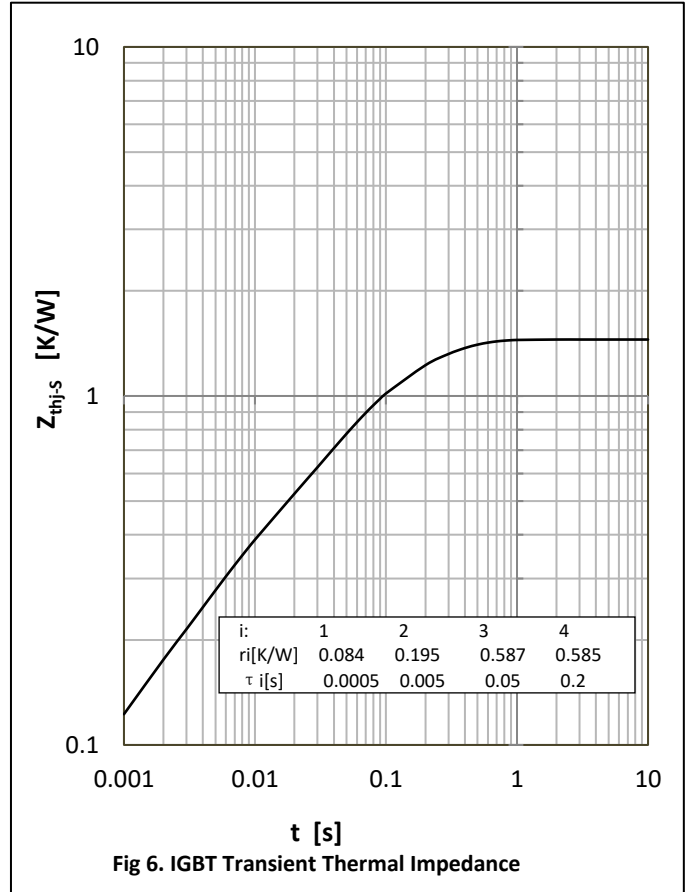
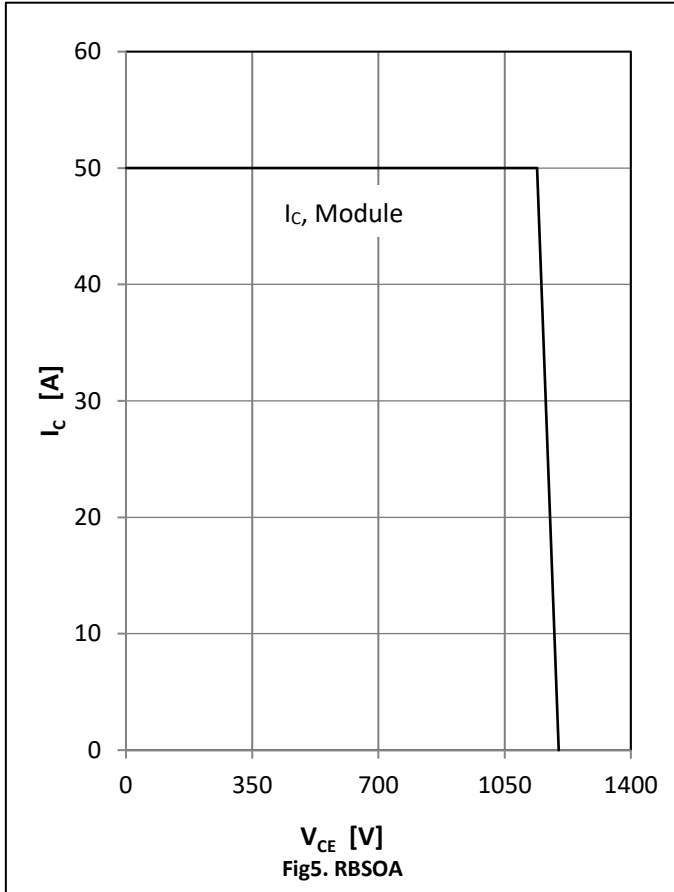

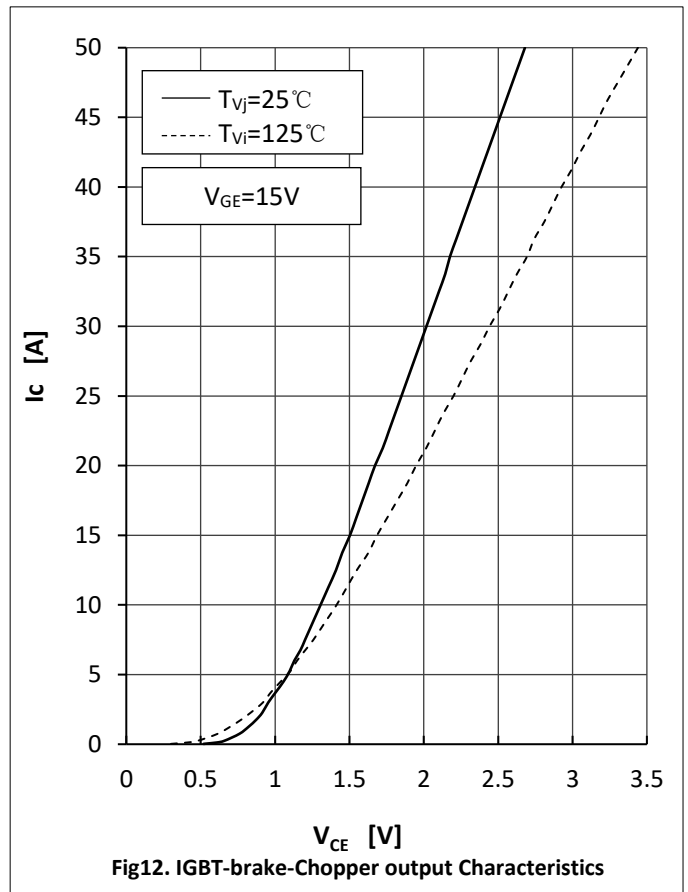
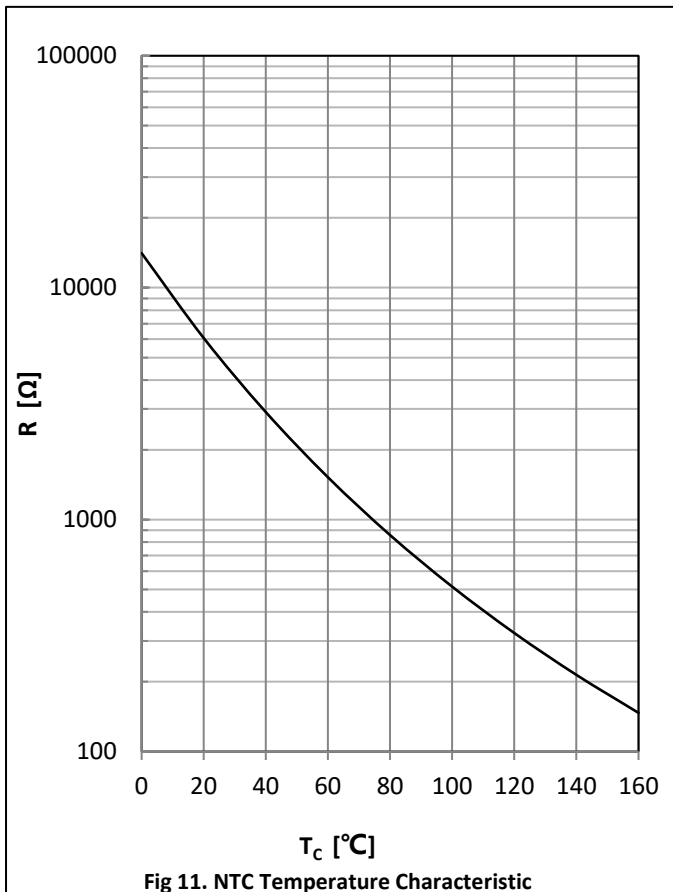
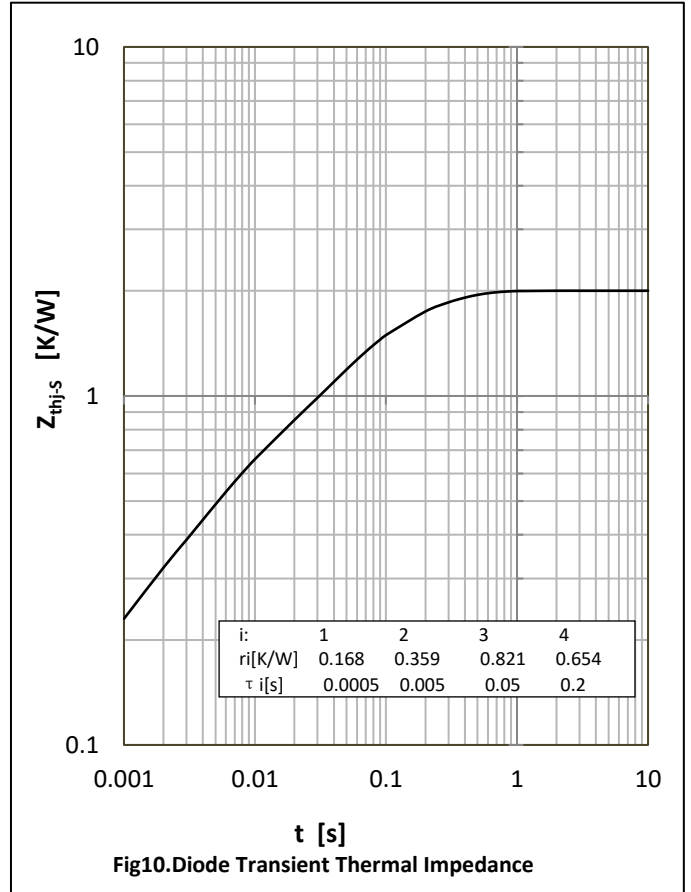
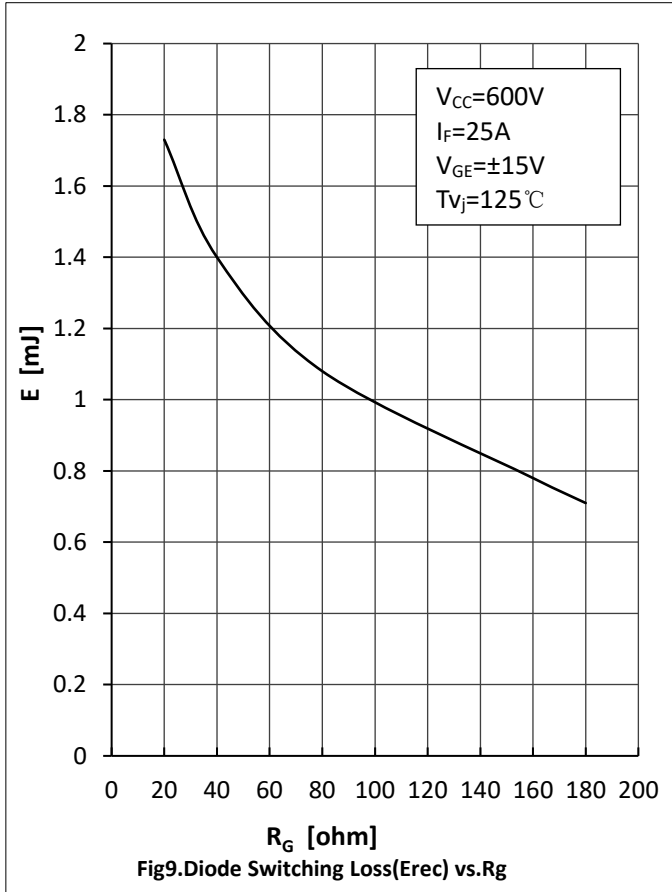

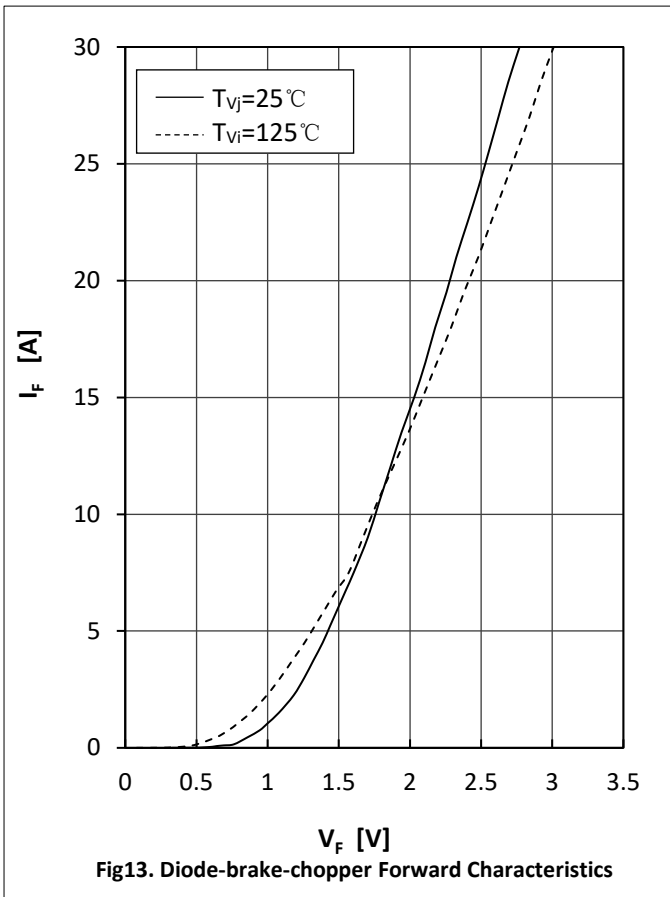



Circuit Diagram

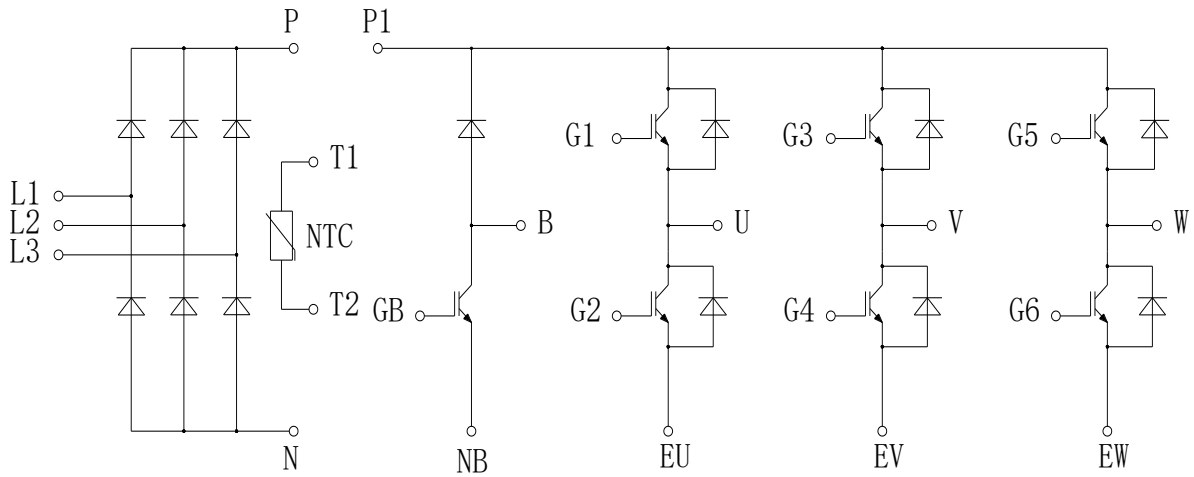

Package Dimensions

