

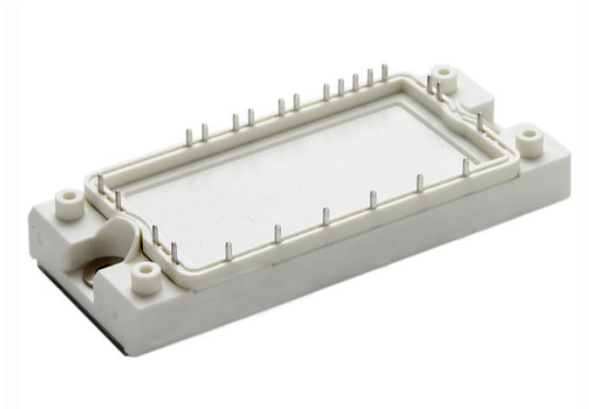

IGBT Modules



V_{CES} 1200V
I_C 25A

Applications

- Motor Drivers
- AC and DC servo drive amplifier
- UPS (Uninterruptible Power Supplies)

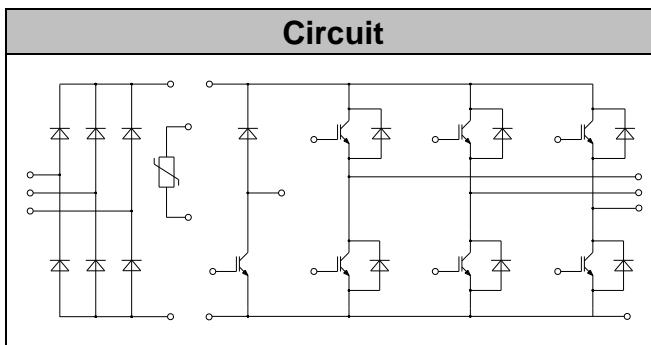

Features

- Low switching losses
- Low $V_{ce(sat)}$ with positive temperature coefficient
- Including fast & soft recovery anti-parallel FWD
- Low inductance case
- High short circuit capability(10us)
- Maximum junction temperature 175°C

● IGBT- inverter

Absolute Maximum Ratings

Parameter	Symbol	Conditions	Value	Unit
Collector-Emitter Voltage	V_{CES}	$V_{GE}=0V, I_C=1mA, T_{vj}=25^{\circ}C$	1200	V
Continuous Collector Current	I_C	$T_c=100^{\circ}C, T_{vjmax}=175^{\circ}C$	25	A
Repetitive Peak Collector Current	I_{CRM}	$t_p=1ms$	50	A
Gate-Emitter Voltage	V_{GES}	$T_{vj}=25^{\circ}C$	± 20	V
Total Power Dissipation	P_{tot}	$T_c=25^{\circ}C,$ $T_{vjmax}=175^{\circ}C$	158	W



Characteristic values

Parameter	Symbol	Conditions	Value			Unit	
			Min.	Typ.	Max.		
Gate-Emitter Threshold Voltage	$V_{GE(th)}$	$V_{GE}=V_{CE}, I_C=0.8mA, T_{vj}=25^{\circ}C$	5.2	5.8	6.4	V	
Collector-Emitter Cut-off Current	I_{CES}	$V_{CE}=1200V, V_{GE}=0V, T_{vj}=25^{\circ}C$			1.0	mA	
Collector-Emitter Saturation Voltage	$V_{CE(sat)}$	$I_C=25A, V_{GE}=15V, T_{vj}=25^{\circ}C$		1.85	2.25	V	
		$I_C=25A, V_{GE}=15V, T_{vj}=125^{\circ}C$		2.15			
		$I_C=25A, V_{GE}=15V, T_{vj}=150^{\circ}C$		2.25			
Gate Charge	Q_G			0.20		μC	
Input Capacitance	C_{ies}	$V_{CE}=25V, V_{GE}=0V,$ $f=1MHz, T_{vj}=25^{\circ}C$		1.45		nF	
Reverse Transfer Capacitance	C_{res}			0.05		nF	
Gate-Emitter leakage current	I_{GES}	$V_{CE}=0V, V_{GE}=20V, T_{vj}=25^{\circ}C$			100	nA	
Turn-on Delay Time	$t_{d(on)}$	$I_C=25A$ $V_{CE}=600V$ $V_{GE}=\pm 15V$ $R_G=18\Omega$ $T_{vj}=25^{\circ}C$		158		ns	
Rise Time	t_r			32		ns	
Turn-off Delay Time	$t_{d(off)}$			331		ns	
Fall Time	t_f			83		ns	
Energy Dissipation During Turn-on Time	E_{on}				1.80		mJ
Energy Dissipation During Turn-off Time	E_{off}				1.40		mJ
Turn-on Delay Time	$t_{d(on)}$		$I_C=25A$ $V_{CE}=600V$ $V_{GE}=\pm 15V$ $R_G=18\Omega$ $T_{vj}=125^{\circ}C$		172		ns
Rise Time	t_r				435		ns
Turn-off Delay Time	$t_{d(off)}$				154		ns
Fall Time	t_f				212		ns
Energy Dissipation During Turn-on Time	E_{on}				2.4		mJ
Energy Dissipation During Turn-off Time	E_{off}				2.18		mJ



Turn-on Delay Time	$t_{d(on)}$	$I_C = 25\text{ A}$ $V_{CE} = 600\text{ V}$ $V_{GE} = \pm 15\text{ V}$ $R_G = 18\ \Omega$ $T_{vj} = 150\text{ }^\circ\text{C}$	174	ns
Rise Time	t_r		43	ns
Turn-off Delay Time	$t_{d(off)}$		452	ns
Fall Time	t_f		174	ns
Energy Dissipation During Turn-on Time	E_{on}		2.65	mJ
Energy Dissipation During Turn-off Time	E_{off}		2.40	mJ
SC Data	I_{sc}		$T_p \leq 10\ \mu\text{s}, V_{GE} = 15\text{ V}, T_{vj} = 150\text{ }^\circ\text{C},$ $V_{cc} = 900\text{ V}, V_{CEM} \leq 1200\text{ V}$	90

● Diode-inverter

Absolute Maximum Ratings

Parameter	Symbol	Conditions	Value	Unit
Repetitive Peak Reverse Voltage	V_{RRM}	$T_{vj} = 25\text{ }^\circ\text{C}$	1200	V
Continuous DC Forward Current	I_F		25	A
Repetitive Peak Forward Current	I_{FRM}	$t_p = 1\text{ ms}$	50	A
I^2t -value	I^2t	$V_R = 0, t_p = 10\text{ ms}, T_{vj} = 125\text{ }^\circ\text{C}$	90.0	A ² s
		$V_R = 0, t_p = 10\text{ ms}, T_{vj} = 150\text{ }^\circ\text{C}$	75.0	

Characteristic values

Parameter	Symbol	Conditions	Value			Unit
			Min.	Typ.	Max.	
Forward Voltage	V_F	$I_F = 25\text{ A}, T_{vj} = 25\text{ }^\circ\text{C}$		1.75	2.25	V
		$I_F = 25\text{ A}, T_{vj} = 125\text{ }^\circ\text{C}$		1.75		
		$I_F = 25\text{ A}, T_{vj} = 150\text{ }^\circ\text{C}$		1.75		
Recovered Charge	Q_{rr}	$I_F = 25\text{ A}$		2.52		μC
Peak Reverse Recovery Current	I_{rr}	$V_R = 600\text{ V}$ $-di_F/dt = 900\text{ A}/\mu\text{s}$		48.5		A
Reverse Recovery Energy	E_{rec}	$T_{vj} = 25\text{ }^\circ\text{C}$		0.94		mJ
Recovered Charge	Q_{rr}	$I_F = 25\text{ A}$		50.8		μC
Peak Reverse Recovery Current	I_{rr}	$V_R = 600\text{ V}$ $-di_F/dt = 900\text{ A}/\mu\text{s}$		50.0		A
Reverse Recovery Energy	E_{rec}	$T_{vj} = 125\text{ }^\circ\text{C}$		1.75		mJ



● IGBT-brake-chopper

Absolute Maximum Ratings

Parameter	Symbol	Conditions	Value	Unit
Collector-Emitter Voltage	V_{CES}	$V_{GE}=0V, I_c=1mA, T_{vj}=25^{\circ}C$	1200	V
Continuous Collector Current	I_c	$T_c=100^{\circ}C, T_{vjmax}=175^{\circ}C$	15	A
Repetitive Peak Collector Current	I_{CRM}	$t_p=1ms$	30	A
Gate-Emitter Voltage	V_{GES}	$T_{vj}=25^{\circ}C$	± 20	V
Total Power Dissipation	P_{tot}	$T_c=25^{\circ}C, T_{vjmax}=175^{\circ}C$	105	W

Characteristic values

Parameter	Symbol	Conditions	Value			Unit
			Min.	Typ.	Max.	
Gate-Emitter Threshold Voltage	$V_{GE(th)}$	$V_{GE}=V_{CE}, I_c=0.5mA, T_{vj}=25^{\circ}C$	5.2	5.8	6.4	V
Collector-Emitter Cut-off Current	I_{CES}	$V_{CE}=1200V, V_{GE}=0V, T_{vj}=25^{\circ}C$			1.0	mA
Collector-Emitter Saturation Voltage	$V_{CE(sat)}$	$I_c=15A, V_{GE}=15V, T_{vj}=25^{\circ}C$		1.85	2.25	V
		$I_c=15A, V_{GE}=15V, T_{vj}=125^{\circ}C$		2.15		
		$I_c=15A, V_{GE}=15V, T_{vj}=150^{\circ}C$		2.25		
Gate Charge	Q_G			0.12		μC
Input Capacitance	C_{ies}	$V_{CE}=25V, V_{GE}=0V,$ $f=1MHz, T_{vj}=25^{\circ}C$		0.89		nF
Reverse Transfer Capacitance	C_{res}			0.03		nF
Gate-Emitter leakage current	I_{GES}	$V_{CE}=0V, V_{GE}=20V, T_{vj}=25^{\circ}C$			100	nA



Turn-on Delay Time	$t_{d(on)}$	$I_C = 15\text{ A}$ $V_{CE} = 600\text{ V}$ $V_{GE} = \pm 15\text{ V}$ $R_G = 39\Omega$ $T_{vj} = 25^\circ\text{C}$		55		ns
Rise Time	t_r			59		ns
Turn-off Delay Time	$t_{d(off)}$			195		ns
Fall Time	t_f			145		ns
Energy Dissipation During Turn-on Time	E_{on}			1.25		mJ
Energy Dissipation During Turn-off Time	E_{off}			0.83		mJ
Turn-on Delay Time	$t_{d(on)}$	$I_C = 15\text{ A}$ $V_{CE} = 600\text{ V}$ $V_{GE} = \pm 15\text{ V}$ $R_G = 39\Omega$ $T_{vj} = 125^\circ\text{C}$		55		ns
Rise Time	t_r			65		ns
Turn-off Delay Time	$t_{d(off)}$			275		ns
Fall Time	t_f			190		ns
Energy Dissipation During Turn-on Time	E_{on}			1.75		mJ
Energy Dissipation During Turn-off Time	E_{off}			1.20		mJ
Turn-on Delay Time	$t_{d(on)}$	$I_C = 15\text{ A}$ $V_{CE} = 600\text{ V}$ $V_{GE} = \pm 15\text{ V}$ $R_G = 39\Omega$ $T_{vj} = 150^\circ\text{C}$		55		ns
Rise Time	t_r			65		ns
Turn-off Delay Time	$t_{d(off)}$			280		ns
Fall Time	t_f			215		ns
Energy Dissipation During Turn-on Time	E_{on}			1.95		mJ
Energy Dissipation During Turn-off Time	E_{off}			1.35		mJ
SC Data	I_{sc}	$T_p \leq 10\mu\text{s}, V_{GE} = 15\text{ V}, T_{vj} = 150^\circ\text{C},$ $V_{cc} = 900\text{ V}, V_{CEM} \leq 1200\text{ V}$		55		A



● Diode-Brake-Chopper

Absolute Maximum Ratings

Parameter	Symbol	Conditions	Value	Unit
Repetitive Peak Reverse Voltage	V_{RRM}	$T_j=25^{\circ}\text{C}$	1200	V
Continuous DC Forward Current	I_F		15	A
Repetitive Peak Forward Current	I_{FRM}	$t_p=1\text{ms}$	30	A
I^2t -value	I^2t	$V_R=0, t_p=10\text{ms}, T_j=125^{\circ}\text{C}$	40.0	A^2s
		$V_R=0, t_p=10\text{ms}, T_j=150^{\circ}\text{C}$	34.0	

Characteristic values

Parameter	Symbol	Conditions	Value			Unit
			Min.	Typ.	Max.	
Forward Voltage	V_F	$I_F=15\text{A}, T_{vj}=25^{\circ}\text{C}$		1.75	2.15	V
		$I_F=15\text{A}, T_{vj}=125^{\circ}\text{C}$		1.75		
		$I_F=15\text{A}, T_{vj}=150^{\circ}\text{C}$		1.75		
Recovered Charge	Q_{rr}	$I_F = 15 \text{ A}$		1.30		μC
Peak Reverse Recovery Current	I_{rr}	$V_R=600\text{V}$ $-di_F/dt = 550\text{A}/\mu\text{s}$		18.8		A
Reverse Recovery Energy	E_{rec}	$T_{vj}=25^{\circ}\text{C}$		0.54		mJ
Recovered Charge	Q_{rr}	$I_F = 15 \text{ A}$		2.40		μC
Peak Reverse Recovery Current	I_{rr}	$V_R=600\text{V}$ $-di_F/dt = 550\text{A}/\mu\text{s}$		19.4		A
Reverse Recovery Energy	E_{rec}	$T_{vj}=125^{\circ}\text{C}$		0.86		mJ
Recovered Charge	Q_{rr}	$I_F = 15 \text{ A}$		2.70		μC
Peak Reverse Recovery Current	I_{rr}	$V_R=600\text{V}$ $-di_F/dt = 550\text{A}/\mu\text{s}$		20.2		A
Reverse Recovery Energy	E_{rec}	$T_{vj}=150^{\circ}\text{C}$		0.95		mJ



● Diode-Rectifier

Absolute Maximum Ratings

Parameter	Symbol	Conditions	Value	Unit
Repetitive Peak Reverse Voltage	V_{RRM}	$T_j=25^{\circ}\text{C}$	1600	V
Average On-state Current 50/60Hz, sine wave	$I_{F(AV)}$	$T_c=100^{\circ}\text{C}$	30	A
Maximum RMS Current at Rectifier Output	I_{RMSM}	$T_c=100^{\circ}\text{C}$	60	A
Surge Forward Current	I_{FSM}	$V_R=0, t_p=10\text{ms}, T_j=45^{\circ}\text{C}$	320	A
I^2t -value	I^2t	$V_R=0, t_p=10\text{ms}, T_j=45^{\circ}\text{C}$	510	A^2s

Characteristic values

Parameter	Symbol	Conditions	Value			Unit
			Min.	Typ.	Max.	
Diode Forward Voltage	V_F	$I_F=25\text{A}, T_j=150^{\circ}\text{C}$		1.02		V
Reverse Current	I_R	$T_j=125, V_R=1600\text{V}$			2	mA

● NTC-Thermistor

Characteristic values

Parameter	Symbol	Conditions	Value			Unit
			Min.	Typ.	Max.	
Rated Resistance	R_{25}			5.0		$\text{k}\Omega$
Deviation of R_{100}	$\Delta R/R$	$T_C=100, R_{100}=493.3\Omega$	-5		5	%
Power Dissipation	P_{25}			20.0		mW
B-value	$B_{25/50}$	$R_2=R_{25}\exp[B_{25/50}(1/T_2-1/(298.15\text{K}))]$		3375		K



● **Module Characteristics** $T_C=25^{\circ}\text{C}$ unless otherwise specified

Parameter	Symbol	Conditions	Value			Unit
			Min.	Typ.	Max.	
Isolation voltage	V_{isol}	$t=1\text{min}, f=50\text{Hz}$	2500			V
Maximum Junction Temperature	T_{jmax}	Inverter, brake			175	$^{\circ}\text{C}$
		rectifier			150	
Operating Junction Temperature	T_{vjop}		-40		150	$^{\circ}\text{C}$
Storage Temperature	T_{stg}		-40		125	$^{\circ}\text{C}$
Stray Inductance	L_{CE}			60		nH
Module Lead Resistance ,Terminal to Chip	$R_{CC'+EE'}$	$T_C=25^{\circ}\text{C}$, per switch		4.0		$\text{m}\Omega$
	$R_{AA'+CC'}$			3.0		
Thermal Resistance Junction-to Case	$R_{\theta jc}$	per IGBT-inverter			0.95	K/W
		per Diode-inverter			1.35	
		per IGBT-brake-chopper			1.40	
		per Diode-chopper			2.3	
		per Diode-rectifier			1.15	
Thermal Resistance Case-to Sink	$R_{\theta cs}$	per IGBT-inverter		0.36		K/W
		per Diode-inverter		0.51		
		per IGBT-brake-chopper		0.53		
		per Diode-chopper		0.88		
		per Diode-rectifier		0.49		
		per Module		0.02		
Module-to-Sink Torque	M_s		3.0		6.0	N·m
Weight of Module	G			180		g



Performance Curves Circuit Diagram

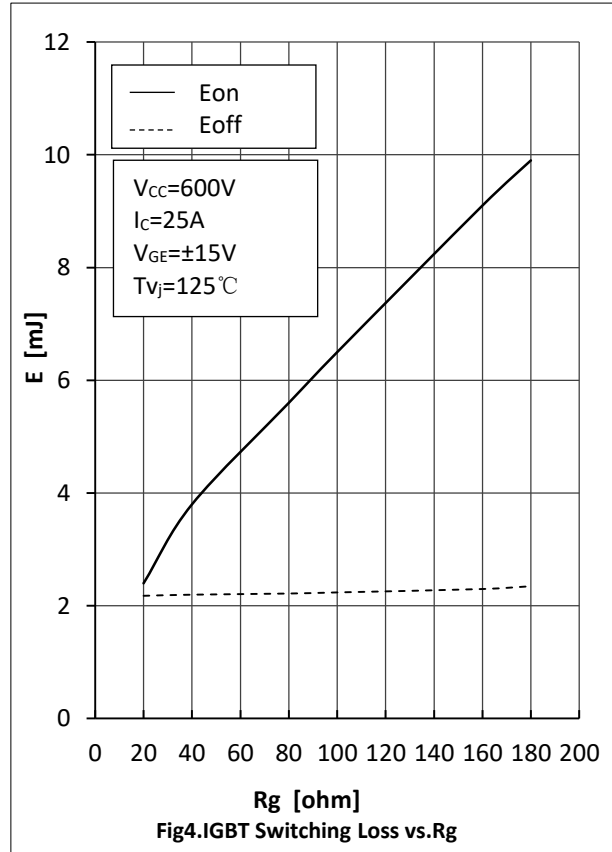
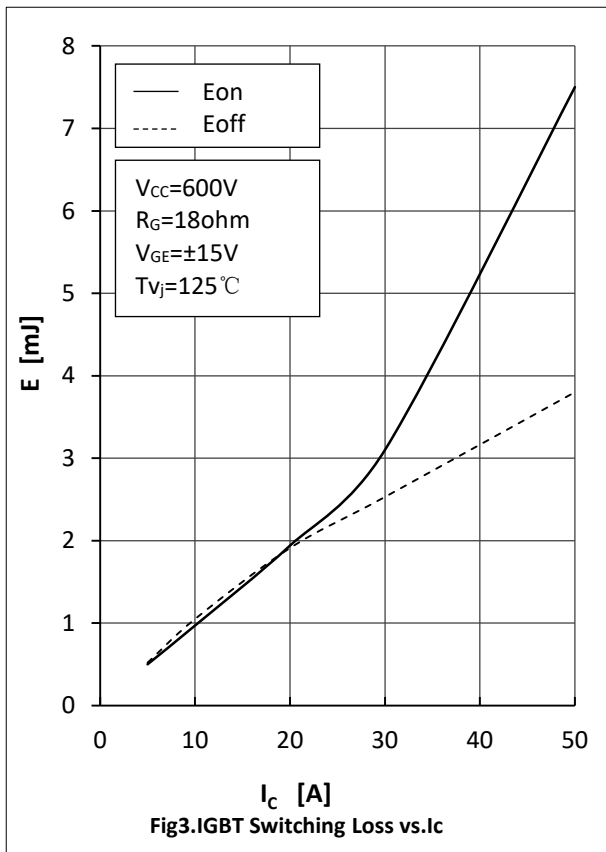
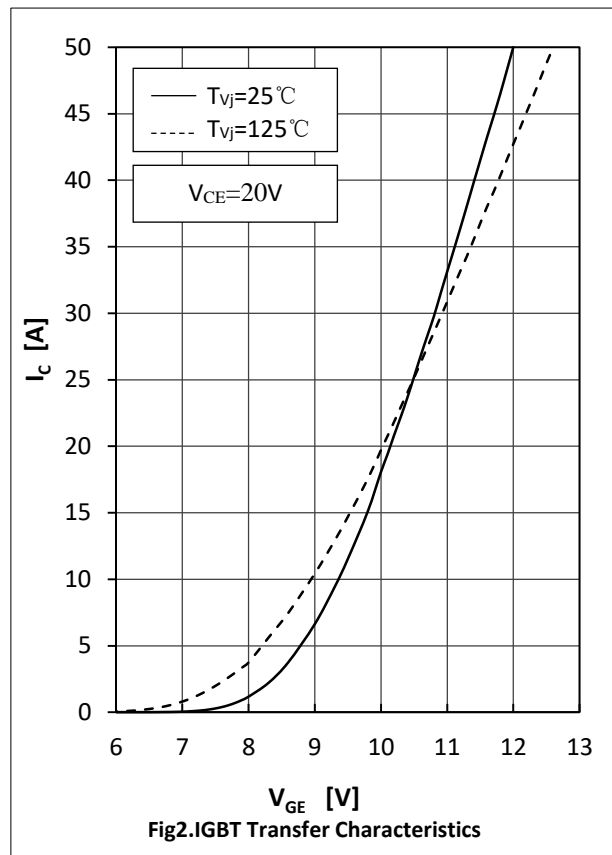
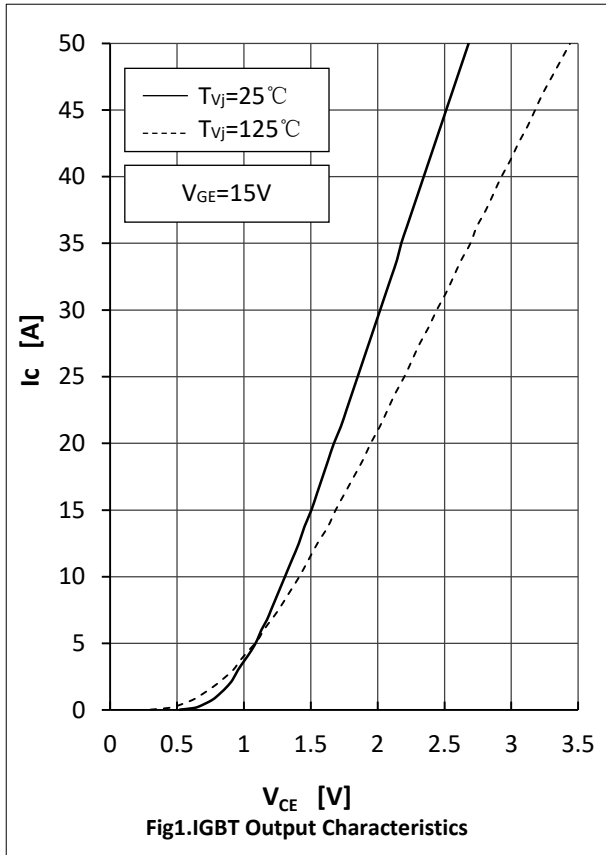

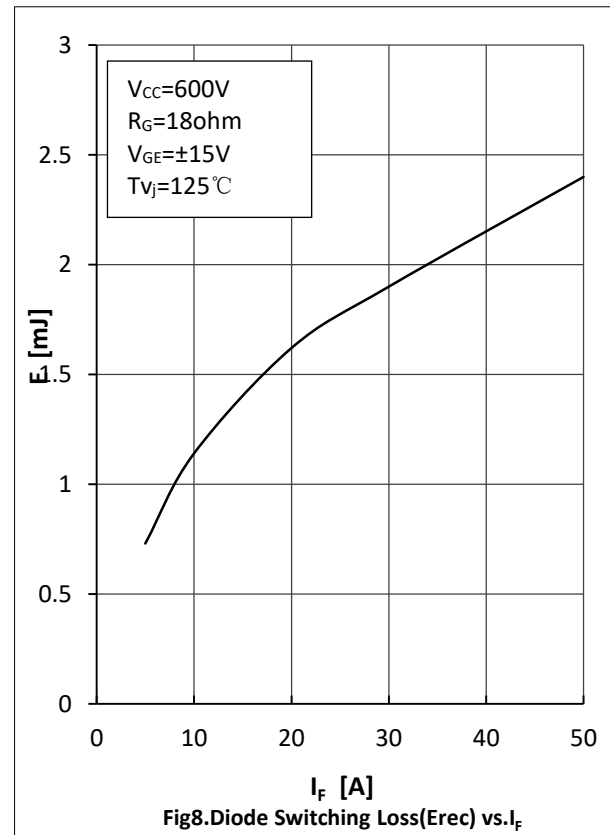
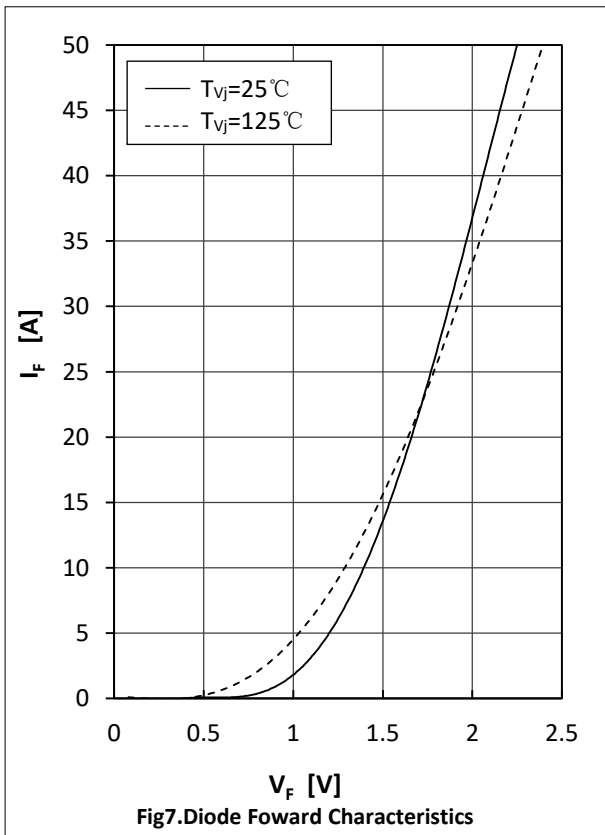
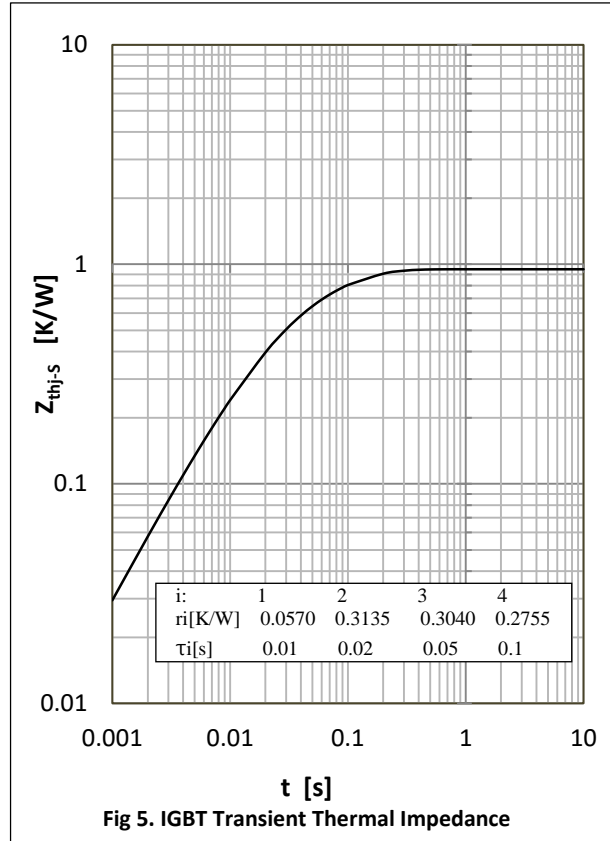
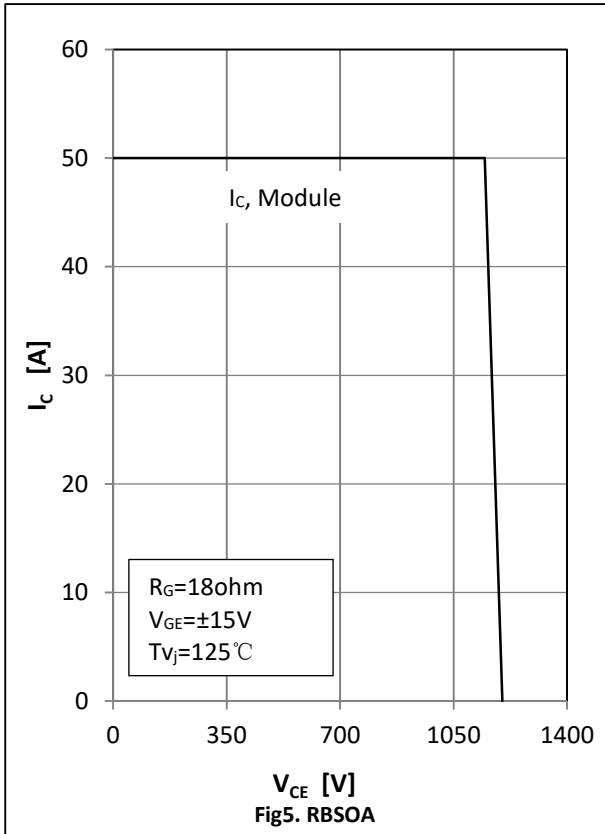

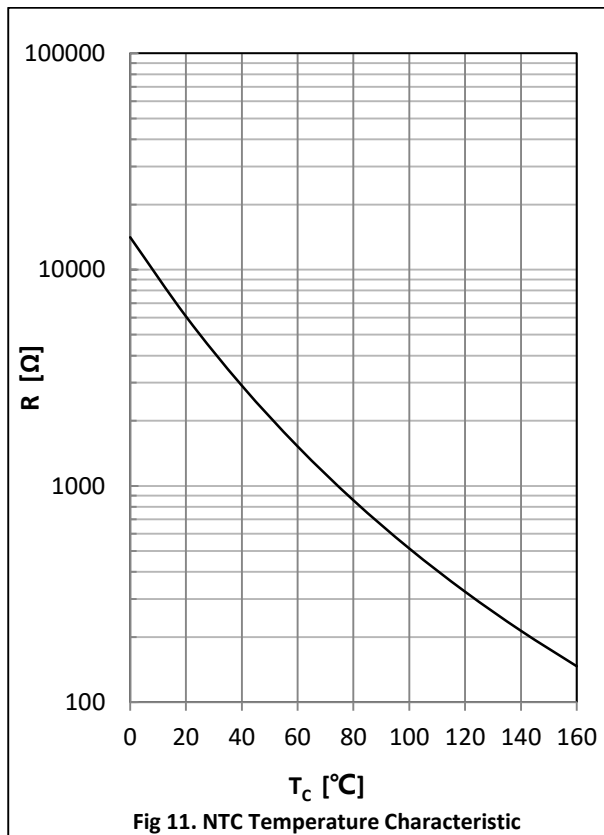
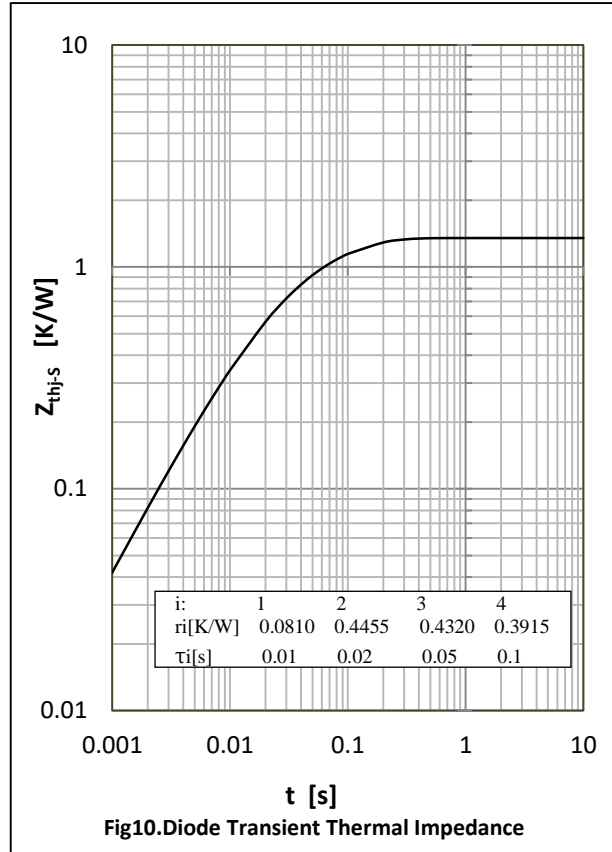
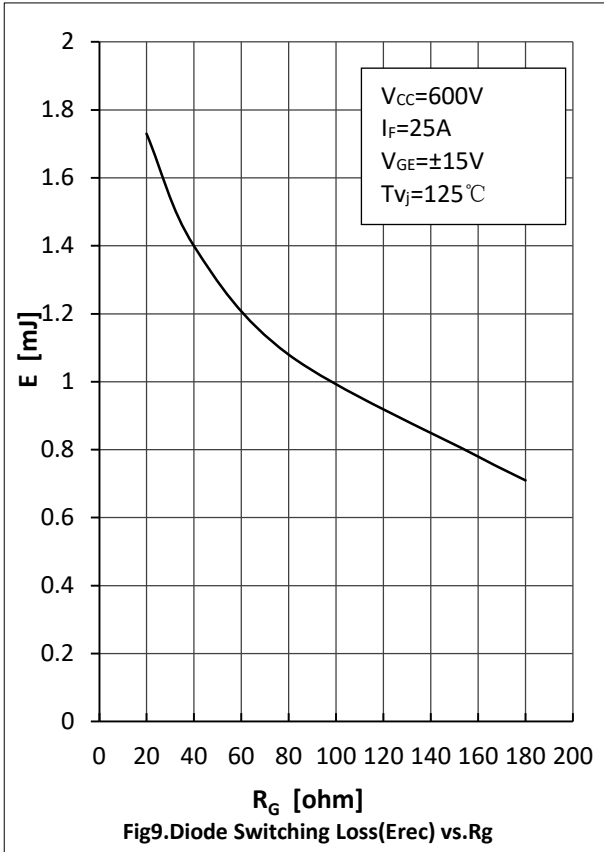



Circuit Diagram

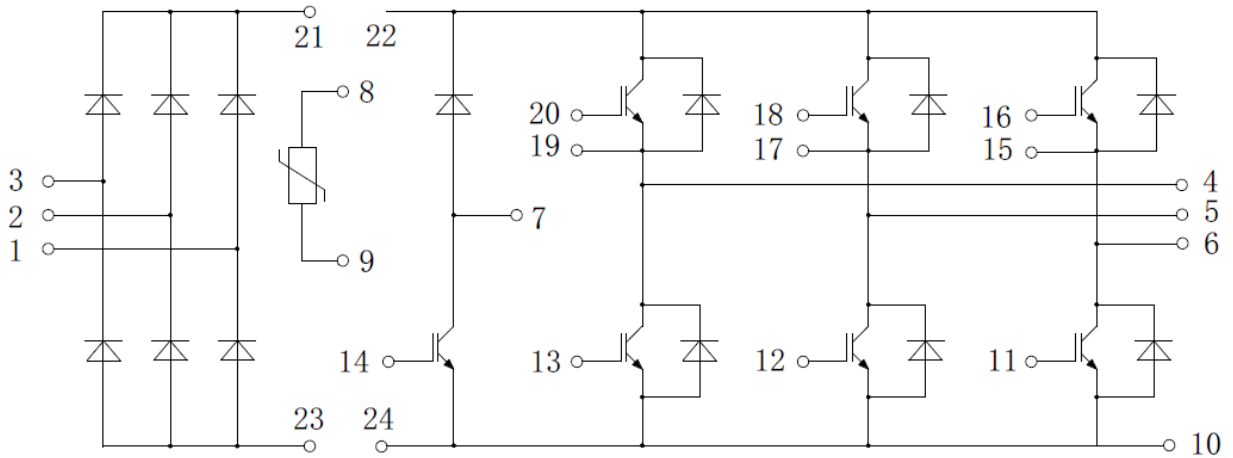

Package Dimensions

Dimensions in Millimeters

