

PNP General Purpose Amplifier

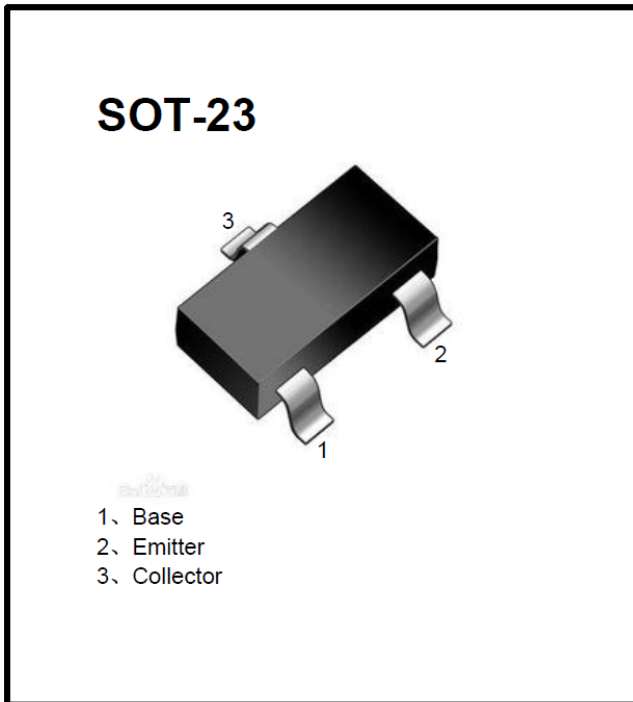

Features

- We declare that the material of product compliance with RoHS requirements and Halogen Free
- Surface mount package ideally suited for automatic insertion
- Moisture Sensitivity Level 1
- Low equivalent on-resistance

Mechanical Data

- Package: SOT-23
- Terminals: Tin plated leads, solderable per J-STD-002 and JESD22-B102
- Marking: 591

■ Equivalent Circuit

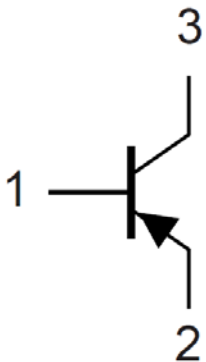



■ Maximum Ratings (Ta=25°C Unless otherwise specified)

Item	Symbol	Unit	Conditions	Value
Collector-Base Voltage	V_{CBO}	V	$I_C=-100\mu A, I_E=0$	-80
Collector-Emitter Voltage	V_{CEO}	V	$I_C=-10mA, I_B=0$	-60
Emitter-Base Voltage	V_{EBO}	V	$I_E=-100\mu A, I_C=0$	-5
Collector Current	I_C	A		-1
Collector Power Dissipation	P_C	mW		300
Thermal Resistance From Junction to Ambient	$R_{\theta JA}$	°C/W		417
Operation Junction Temperature	T_J	°C		150
Storage Temperature	T_{STG}	°C		-55 to +150

■ Electrical Characteristics (Ta=25°C Unless otherwise specified)

Item	Symbol	Unit	Conditions	Min	Type	Max
Collector-base breakdown voltage	$V_{(BR)CBO}$	V	$I_C=-100\mu A, I_E=0$	-80		
Collector-emitter breakdown voltage	$V_{(BR)CEO}$	V	$I_C=-10mA, I_B=0$	-60		
Emitter-base breakdown voltage	$V_{(BR)EBO}$	V	$I_E=-100\mu A, I_C=0$	-5		
Collector-Base cut-off current	I_{CBO}	uA	$V_{CB}=-60V, I_E=0$			-0.1
Emitter-Base cut-off current	I_{EBO}	uA	$V_{EB}=-4V, I_C=0$			-0.1
DC current gain	h_{FE1}		$V_{CE}=-5V, I_C=-1mA$	100		
	h_{FE2}		$V_{CE}=-5V, I_C=-500mA$	100		300
	h_{FE3}		$V_{CE}=-5V, I_C=-1A$	80		
	h_{FE4}		$V_{CE}=-5V, I_C=-2A$	15		
Collector-emitter saturation voltage	$V_{CE(sat)}$	V	$I_C=-500mA, I_B=-50mA$			-0.3
		V	$I_C=-1A, I_B=-100mA$			-0.6
Base-emitter saturation voltage	$V_{BE(sat)}$	V	$I_C=-1A, I_B=-100mA$			-1.2
Base-emitter voltage	V_{BE}	V	$V_{CE}=-5V, I_C=-1A$			-1
Transition frequency	f_T	MHz	$V_{CE}=-10V, I_C=-50mA, f=100MHz$	150		
Collector-Base Output Capacitance	C_{ob}	pF	$V_{CB}=-10V, I_E=0, f=1MHz$		10	



Electrical Characteristics (Typical)

Static Characteristic

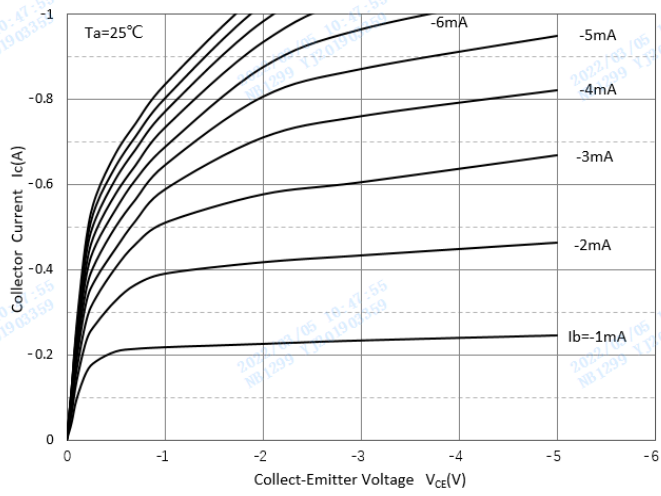

DC Current Gain

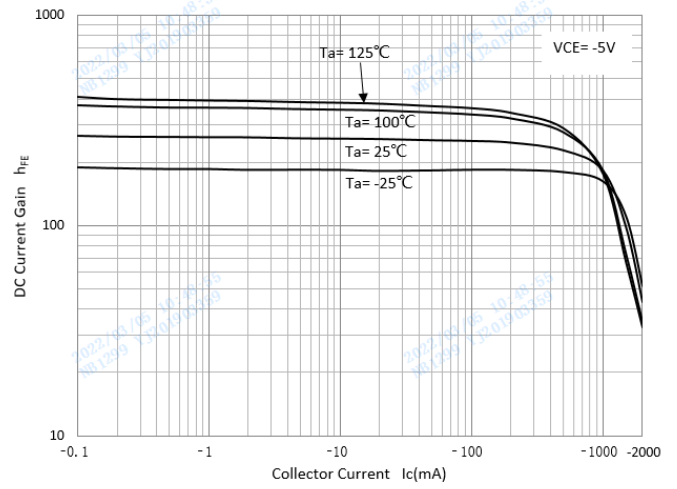

Collector-Emmitter Saturation Voltage

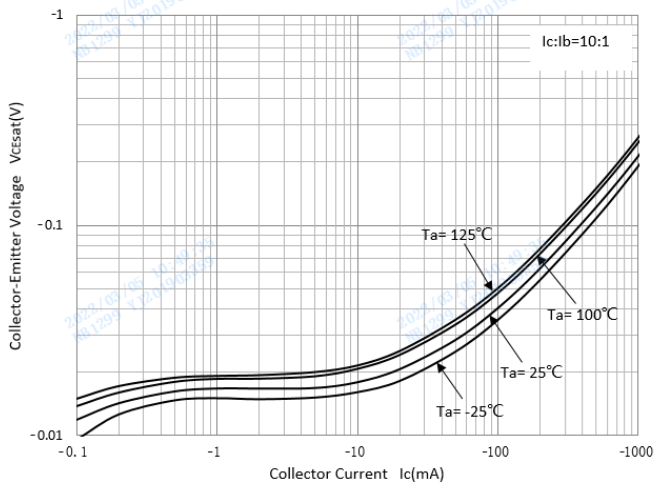

Base-Emmitter Saturation Voltage

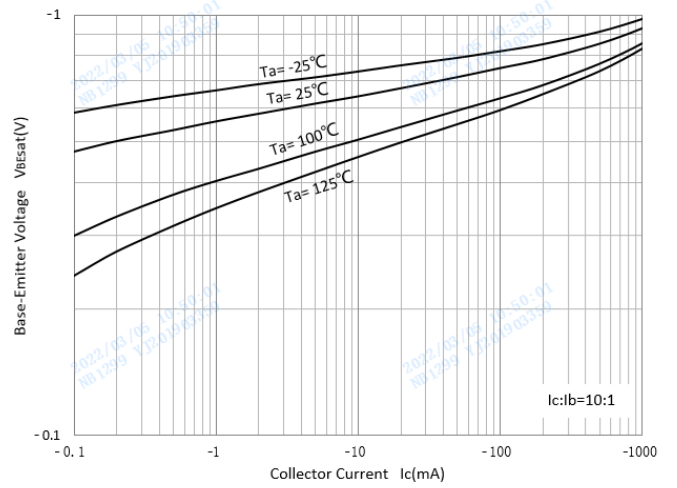

Base-Emmitter On Voltage

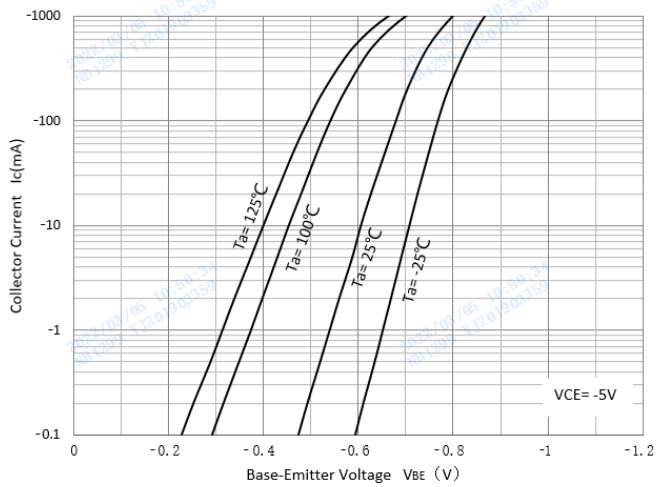

Cob/Cib-V_{CB}/V_{EB}

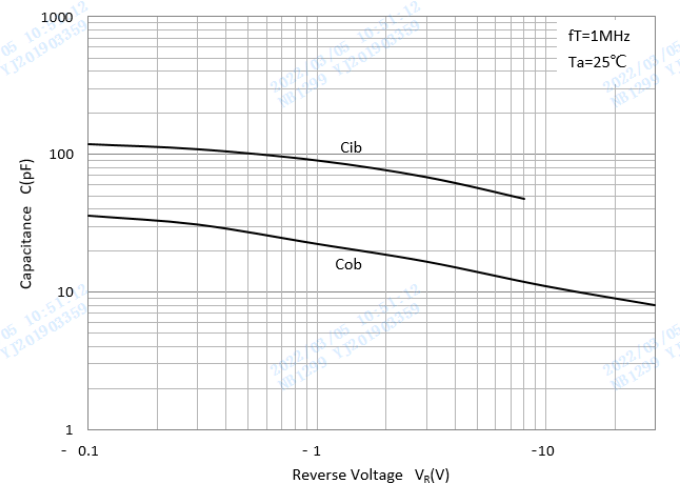

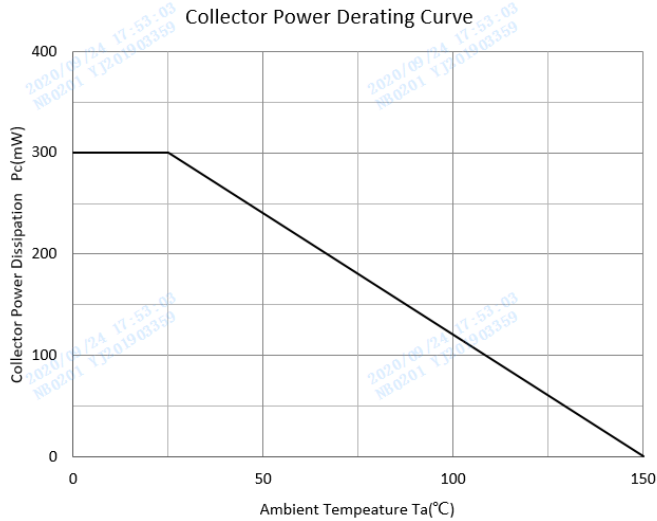

Ordering Information (Example)

PREFERRED P/N	PACKING CODE	UNIT WEIGHT(g)	MINIMUM PACKAGE(pcs)	INNER BOX QUANTITY(pcs)	OUTER CARTON QUANTITY(pcs)	DELIVERY MODE
FMMT591	F2	Approximate 0.008	3000	30000	120000	7" reel

SOT-23 Package Outline Dimensions

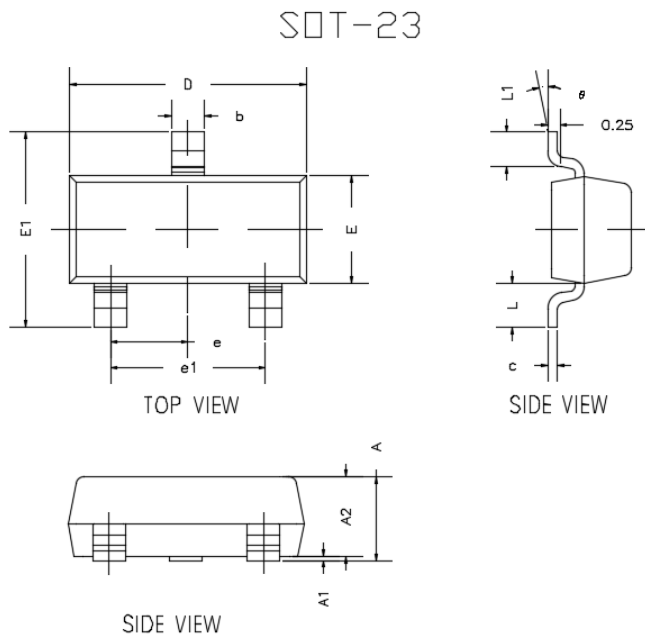

DIMENSIONS				
DIM	INCHES		MM	
	MIN	MAX	MIN	MAX
A	0.035	0.045	0.900	1.150
A1	0.000	0.004	0.000	0.100
A2	0.035	0.041	0.900	1.050
b	0.012	0.020	0.300	0.500
c	0.004	0.008	0.100	0.200
D	0.110	0.118	2.800	3.000
E	0.047	0.055	1.200	1.400
E1	0.089	0.100	2.250	2.550
e	0.037TYP		0.95TYP	
e1	0.071	0.079	1.800	2.000
L	0.022TYP		0.55TYP	
L1	0.012	0.020	0.300	0.500
θ	0°	8°	0°	8°



■SOT-23 Soldering Footprint

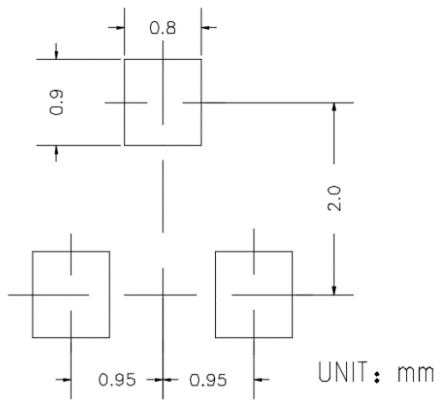

SUGGESTED SOLDER PAD LAYOUT



Disclaimer

The information presented in this document is for reference only. Yangzhou Yangjie Electronic Technology Co., Ltd. reserves the right to make changes without notice for the specification of the products displayed herein to improve reliability, function or design or otherwise.

The product listed herein is designed to be used with ordinary electronic equipment or devices, and not designed to be used with equipment or devices which require high level of reliability and the malfunction of which would directly endanger human life (such as medical instruments, transportation equipment, aerospace machinery, nuclear-reactor controllers, fuel controllers and other safety devices), Yangjie or anyone on its behalf, assumes no responsibility or liability for any damages resulting from such improper use of sale.

This publication supersedes & replaces all information previously supplied. For additional information, please visit our website [http:// www.21yangjie.com](http://www.21yangjie.com) , or consult your nearest Yangjie's sales office for further assistance.