

Small-Signal Fast Switching Diodes

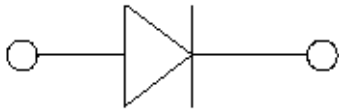

Features

- V_R 100V
- I_{FAV} 200mA

Typical Applications

- Low-Leakage

Mechanical Data

- **Package:** SOD323
- **Terminals:** Tin plated leads, solderable per J-STD-002 and JESD22-B102
- **Polarity:** Cathode line denotes the cathode end
- **Marking:** D4

■Maximum Ratings ($T_a=25^\circ\text{C}$ Unless otherwise specified)

PARAMETER	SYMBOL	UNIT	Conditions	VALUE
Repetitive peak reverse voltage	V_{RRM}	V		85
Reverse voltage	V_R	V		100
Peak forward surge current	I_{FSM}	A	Non-Repetitive $t = 1 \mu\text{s}$	4
Average forward current	I_{FAV}	mA		200
Power dissipation	P_{tot}	mW		250
Thermal Resistance Junction to Ambient Air	$R_{\theta JA}$	$^\circ\text{C}/\text{W}$		500
Maximum junction temperature	T_j	$^\circ\text{C}$		150
Storage temperature range	T_{stg}	$^\circ\text{C}$		-55 to +150

■Electrical Characteristics ($T_a=25^\circ\text{C}$ Unless otherwise specified)

PARAMETER	Symbol	UNIT	Conditions	Min	Max
Breakdown Voltage	V_R	V	$I_R=100\mu\text{A}$	100	
Forward Voltage	V_F	V	$I_F=1\text{mA}$		0.9
			$I_F=10\text{mA}$		1.0
			$I_F=50\text{mA}$		1.1
			$I_F=150\text{mA}$		1.25
Reverse Leakage Current	I_R	nA	$V_R=75\text{V}$		5
Capacitance	C	pF	$V_R=0\text{V}, f=1\text{MHz}$		4
Reverse Recovery Time	T_{rr}	us	$I_F=I_R=10\text{mA}, I_{rr}=0.1 \cdot I_R, R_L=100\Omega$		3



BAS416

Ordering Information (Example)

PREFERRED P/N	PACKING CODE	UNIT WEIGHT(g)	MINIMUM PACKAGE(pcs)	INNER BOX QUANTITY(pcs)	OUTER CARTON QUANTITY(pcs)	DELIVERY MODE
BAS416	F2	Approximate 0.004	3000	30000	120000	7" reel

Characteristics (Typical)

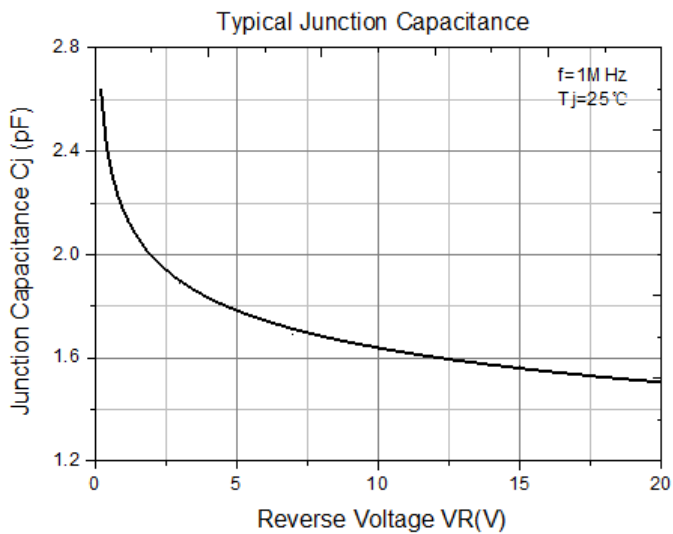
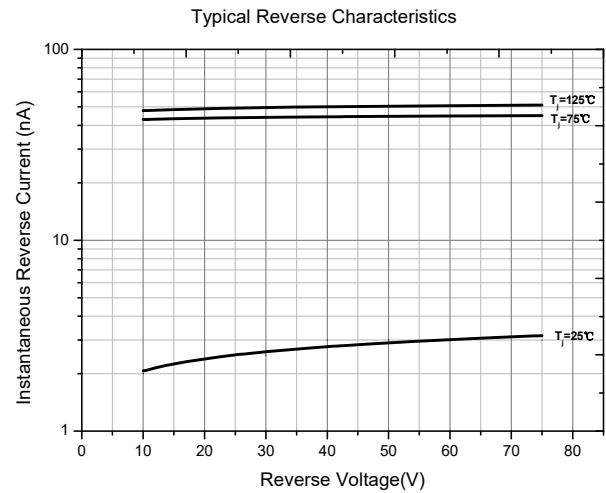
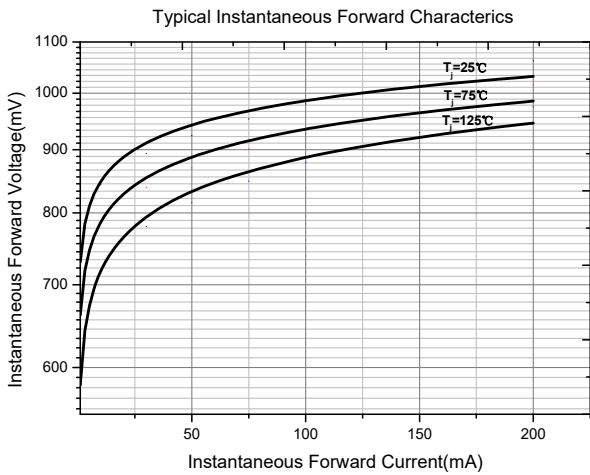



BAS416

■Outline Dimensions

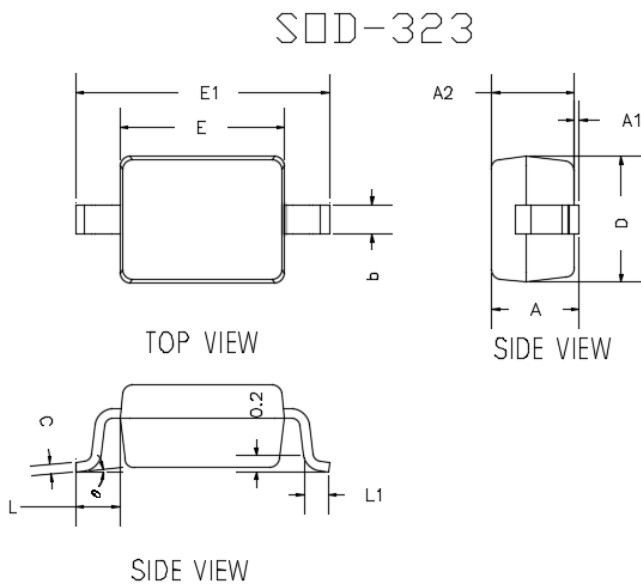

DIMENSIONS				
DIM	INCHES		MM	
	MIN	MAX	MIN	MAX
A	---	0.0393	---	1.0000
A1	0.0000	0.0039	0.0000	0.1000
A2	0.0314	0.0354	0.8000	0.9000
b	0.0098	0.0157	0.2500	0.4000
c	0.0031	0.0059	0.0800	0.1500
D	0.0472	0.0551	1.2000	1.4000
E	0.0629	0.0709	1.6000	1.8000
E1	0.0984	0.1063	2.5000	2.7000
L	0.0187TYP		0.475TYP	
L1	0.0098	0.0157	0.250	0.400
e	0°	8°	0°	8°

■Soldering Footprint

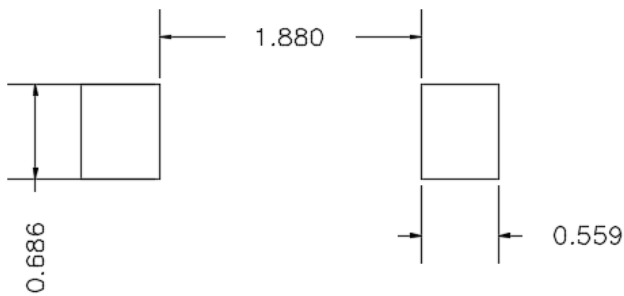

UNIT : mm

SUGGESTED SOLDER PAD LAYOUT



BAS416

Disclaimer

The information presented in this document is for reference only. Yangzhou Yangjie Electronic Technology Co., Ltd. reserves the right to make changes without notice for the specification of the products displayed herein to improve reliability, function or design or otherwise.

The product listed herein is designed to be used with ordinary electronic equipment or devices, and not designed to be used with equipment or devices which require high level of reliability and the malfunction of which would directly endanger human life (such as medical instruments, transportation equipment, aerospace machinery, nuclear-reactor controllers, fuel controllers and other safety devices), Yangjie or anyone on its behalf, assumes no responsibility or liability for any damages resulting from such improper use of sale.

This publication supersedes & replaces all information previously supplied. For additional information, please visit our website [http:// www.21yangjie.com](http://www.21yangjie.com) , or consult your nearest Yangjie's sales office for further assistance.